

CENOVNI K 3A

ИНДУСТРИСКИ ИНСТАЛАЦИИ

BEZRABNA CEVKA OD ^ELIK

STANDARD: DIN 2448 / 1629
 MATERI JAL: ST.37 - ^.1212 / ST.35.8 - ^.1214
 POTEKLO: ^E[KA, ROMANI JA
 DOL@I NA: 5 mtr - 7 mtr
 LEGENDA:
S - DEBELI NA NA YI DOT
D - NADVORE[EN DI JAMETAR

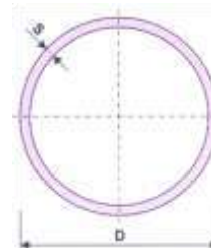

| D, mm | S, mm | kg / mtr | cena / mtr bez DDV | cena / kgr bez DDV |
|-------|-------|----------|-----------------------|-----------------------|
| 10,2 | 1,6 | 0.339 | | |
| 13,5 | 2,0 | 0.567 | | |
| | 2,6 | 0.699 | | |
| 17,2 | 2,3 | 0.845 | | |
| | 2,9 | 1.02 | | |
| 21,3 | 2,3 | 1.08 | | |
| | 2,6 | 1.20 | 107 | 89 |
| | 2,9 | 1.32 | | |
| 26,9 | 2,3 | 1.40 | 125 | 89 |
| | 2,6 | 1.56 | 139 | 89 |
| | 2,9 | 1.72 | 153 | 89 |
| 33,7 | 2,6 | 1.99 | 177 | 89 |
| | 2,9 | 2.20 | | |
| | 3,2 | 2.41 | | |
| 38,0 | 2,6 | 2.27 | | |
| | 2,9 | 2.51 | | |
| | 3,6 | 3.05 | | |
| 42,4 | 2,6 | 2.55 | 227 | 89 |
| | 2,9 | 2.82 | | |
| | 3,2 | 3.09 | | |
| 48,3 | 2,6 | 2.93 | 261 | 89 |
| | 2,9 | 3.25 | | |
| | 3,2 | 3.56 | | |
| 51,0 | 2,6 | 3.10 | | |
| | 2,9 | 3.44 | | |
| | 4,0 | 4.64 | | |
| 57,0 | 2,9 | 3.87 | 231 | 89 |
| | 3,2 | 4.25 | | |
| | 3,6 | 4.74 | | |
| 60,3 | 2,9 | 4.11 | 366 | 89 |
| | 3,2 | 4.51 | | |
| | 3,6 | 5.03 | | |
| 63,5 | 2,9 | 4.33 | | |
| | 3,6 | 5.32 | | |
| | 4,0 | 5.87 | | |
| 70,0 | 2,9 | 4.80 | | |
| | 3,2 | 5.27 | | |
| | 3,6 | 5.90 | | |
| 76,1 | 2,9 | 5.24 | 467 | 89 |
| | 3,2 | 5.75 | | |
| | 3,6 | 6.44 | 574 | 89 |
| | 4,5 | | 708 | 89 |

| D, mm | S, mm | kg / mtr | cena / mtr bez DDV | cena / kgr bez DDV |
|-------|-------|----------|-----------------------|-----------------------|
| 88,9 | 3,2 | 6.76 | 603 | 89 |
| | 3,6 | 7.57 | | |
| | 4,0 | 8.38 | | |
| 101,6 | 3,6 | 8.70 | | |
| | 4,0 | 9.63 | | |
| | 5,0 | 11.90 | | |
| 108,0 | 3,6 | 9.27 | 827 | 89 |
| | 4,0 | 10.30 | 917 | 89 |
| | 4,5 | 11.50 | | |
| 114,3 | 3,6 | 9.80 | 874 | 89 |
| | 4,0 | 10.90 | 970 | |
| | 4,5 | 12.20 | | |
| 133,0 | 4,0 | 12.70 | 1131 | 89 |
| | 5,0 | 15.80 | 1409 | 89 |
| | 6,3 | 19.70 | | |
| | 8,0 | | 2198 | 89 |
| 159,0 | 4,5 | 17.10 | 1552 | 89 |
| | 5,0 | | 1692 | 89 |
| | 5,6 | 21.20 | | |
| | 6,3 | 23.70 | | |
| 168,3 | 4,5 | 18.2 | 1620 | 89 |
| 219,1 | 6,3 | 33.1 | 2947 | 89 |
| | 7,1 | 37.10 | | |
| | 10,0 | 51.60 | | |
| 273,0 | 7,1 | 46.60 | | |
| | 8,0 | 52.30 | | |
| 323,9 | 7,1 | 55.50 | | |
| | 8,0 | 62.30 | | |
| 355,6 | 8,0 | 68.60 | | |
| 406,4 | 11,0 | 107.00 | | |

ZABELE[KA:
 PO NARA^KA NUDI ME I
 VI SOKOPRECI ZNI CEVKI

*цените се во денари

*го задржуваме правото на измени без обврска кон клиентите

STANDARD: ANSI B.36.10

MATERI JAL: API 5L, A 106

POTEKLO: ^E[KA, ROMANI JA

DOL@I NA: 5 mtr - 7 mtr

LEGENDA:

S - DEBELI NA NA YI DOT

D - NADVORE[EN DI JAMETAR

ND - NOMI NALEN DI JAMETAR

| D, mm | DEBELI NA SCH STD | | | | DEBELI NA SCH XS | | | |
|-------|-------------------|-------|----------|------------|------------------|-------|----------|------------|
| | ND, inch | S, mm | kg / mtr | cena / mtr | ND, inch | S, mm | kg / mtr | cena / mtr |
| 21.3 | 1/2" | 2.8 | 1.27 | 304 | 1/2" | 3.7 | 1.62 | 387 |
| 26.7 | 3/4" | 2.9 | 1.68 | 374 | 3/4" | 3.9 | 2.19 | 487 |
| 33.4 | 1" | 3.4 | 2.50 | 524 | 1" | 4.6 | 3.23 | 681 |
| 42.2 | 5/4" | 3.6 | 3.38 | 672 | 5/4" | 4.9 | 4.47 | 888 |
| 48.3 | 6/4" | 3.7 | 4.05 | 756 | 6/4" | 5.1 | 5.41 | 1,010 |
| 60.3 | 2" | 3.9 | 5.44 | 1,017 | 2" | 5.5 | 7.48 | 1,395 |
| 73.0 | 2 1/2" | 5.2 | 8.62 | 1,584 | 2 1/2" | 7.0 | 11.40 | 2,077 |
| 88.9 | 3" | 5.5 | 11.30 | 2,056 | 3" | 7.6 | 15.30 | 2,782 |
| 114.3 | 4" | 6.0 | 16.10 | 2,868 | 4" | 8.6 | 22.30 | 3,992 |
| 141.3 | 5" | 6.6 | 21.80 | 3,957 | 5" | 9.5 | 31.00 | 5,632 |
| 168.3 | 6" | 7.1 | 28.30 | 5,141 | 6" | 11.0 | 42.60 | 7,737 |
| 219.1 | 8" | 8.2 | 42.60 | 8,742 | 8" | 12.7 | 64.60 | 13,285 |
| 273.0 | 10" | 9.3 | 60.30 | 12,392 | 10" | 12.7 | 81.60 | 16,758 |
| 323.8 | 12" | 9.5 | 73.90 | 15,155 | 12" | 12.7 | 97.50 | 19,985 |
| 355.6 | 14" | 9.5 | 81.30 | 16,670 | 14" | 12.7 | 107.00 | 22,023 |

| D, mm | DEBELI NA SCH 20 | | | | DEBELI NA SCH 30 | | | |
|-------|------------------|-------|----------|------------|------------------|-------|----------|------------|
| | ND, inch | S, mm | kg / mtr | cena / mtr | ND, inch | S, mm | kg / mtr | cena / mtr |
| 219.1 | 8" | 6.4 | 33.30 | 6,828 | 8" | 7.0 | 36.80 | 7,550 |
| 273.0 | 10" | 6.4 | 41.80 | 8,572 | 10" | 7.8 | 51.00 | 10,470 |
| 323.8 | 12" | 6.4 | 49.70 | 10,193 | 12" | 8.4 | 65.20 | 13,370 |

| D, mm | DEBELI NA SCH 40 | | | |
|-------|------------------|-------|----------|------------|
| | ND, inch | S, mm | kg / mtr | cena / mtr |
| 323.8 | 12" | 10.3 | 79.70 | 16,390 |
| 355.6 | 14" | 11.1 | 94.50 | 19,400 |

БЕЗРАБНИ ЦРНИ КОЛЕНА

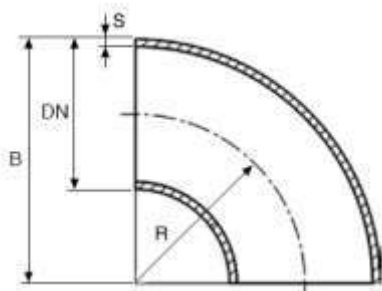
RACCORDERIE METALLICHE

Арт. 704

Безшавни челични колена 90°

Стандарт: EN 10253-1 (DIN 2605)

Материјал: P235TR1 - S235 (R.St.37.0)

| DN | S | | | | Без ДДВ | Со ДДВ |
|-------|-----|--|--|--|---------|--------------|
| мм | мм | | | | ден/пар | ден/пар |
| 17,2 | 2 | | | | 127 | 150 |
| 21,3 | 2 | | | | 64 | 76 |
| 26,9 | 2,3 | | | | 64 | 76 |
| 33,7 | 2,6 | | | | 60 | 71 |
| 42,4 | 2,6 | | | | 71 | 84 |
| 48,3 | 2,6 | | | | 90 | 106 |
| 57 | 2,9 | | | | 159 | 188 |
| 60,3 | 2,9 | | | | 137 | 162 |
| 70 | 2,9 | | | | 195 | 230 |
| 76,1 | 2,9 | | | | 196 | 231 |
| 88,9 | 3,2 | | | | 311 | 367 |
| 101,6 | 3,6 | | | | 505 | 596 |
| 108 | 3,6 | | | | 518 | 611 |
| 114,3 | 3,6 | | | | 534 | 630 |
| 133 | 4 | | | | 935 | 1103 |
| 139,7 | 4 | | | | 1022 | 1206 |
| 159 | 4,5 | | | | 1355 | 1599 |
| 168,3 | 4,5 | | | | 1474 | 1739 |
| 193,7 | 5,6 | | | | 2719 | 3208 |
| 219,1 | 6,3 | | | | 3904 | 4607 |
| 244,5 | 6,3 | | | | 8247 | 9731 |
| 273 | 6,3 | | | | 6995 | 8254 |
| 323,9 | 7,1 | | | | 11311 | 13347 |

БЕЗРАБНИ ЦРНИ КОНЦЕНТРИЧНИ РЕДУЦИРИ

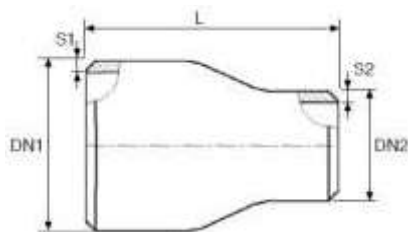

Арт. 276
 Безрабни челични концентрични редуцири
 Стандард: DIN 2616 серија 3

| DN1 | DN2 | S1 | S2 | L | Без ДДВ | Со ДДВ |
|-------|-------|-----|-----|-----|---------|-------------|
| мм | мм | мм | мм | мм | ден/пар | ден/пар |
| 33,7 | 26,9 | 2,6 | 2,3 | 50 | 158 | 186 |
| 42,4 | 26,9 | 2,6 | 2,3 | 50 | 171 | 202 |
| 42,4 | 33,7 | 2,6 | 2,6 | 50 | 156 | 184 |
| 48,3 | 26,9 | 2,6 | 2,3 | 64 | 231 | 273 |
| 48,3 | 33,7 | 2,6 | 2,6 | 64 | 189 | 223 |
| 48,3 | 42,4 | 2,6 | 2,6 | 64 | 162 | 191 |
| 60,3 | 33,7 | 2,9 | 2,6 | 76 | 239 | 282 |
| 60,3 | 42,4 | 2,9 | 2,6 | 76 | 207 | 244 |
| 60,3 | 48,3 | 2,9 | 2,6 | 76 | 182 | 215 |
| 76,1 | 42,4 | 2,9 | 2,6 | 90 | 281 | 332 |
| 76,1 | 48,3 | 2,9 | 2,6 | 90 | 248 | 293 |
| 76,1 | 60,3 | 2,9 | 2,9 | 90 | 226 | 267 |
| 88,9 | 42,4 | 3,2 | 2,6 | 90 | 587 | 693 |
| 88,9 | 48,3 | 3,2 | 2,6 | 90 | 414 | 489 |
| 88,9 | 60,3 | 3,2 | 2,9 | 90 | 326 | 385 |
| 88,9 | 76,1 | 3,2 | 2,9 | 90 | 269 | 317 |
| 101,6 | 60,3 | 3,6 | 2,9 | 100 | 735 | 867 |
| 101,6 | 76,1 | 3,6 | 2,9 | 100 | 499 | 589 |
| 101,6 | 88,9 | 3,6 | 3,2 | 100 | 452 | 533 |
| 108 | 60,3 | 3,6 | 2,9 | 100 | 713 | 841 |
| 108 | 76,1 | 3,6 | 2,9 | 100 | 542 | 640 |
| 108 | 88,9 | 3,6 | 3,2 | 100 | 453 | 535 |
| 114,3 | 60,3 | 3,6 | 2,9 | 100 | 731 | 863 |
| 114,3 | 76,1 | 3,6 | 2,9 | 100 | 567 | 669 |
| 114,3 | 88,9 | 3,6 | 3,2 | 100 | 494 | 583 |
| 114,3 | 101,6 | 3,6 | 3,6 | 100 | 473 | 558 |
| 133 | 76,1 | 4 | 2,9 | 127 | 1310 | 1546 |
| 133 | 88,9 | 4 | 3,2 | 127 | 960 | 1133 |
| 133 | 101,6 | 4 | 3,6 | 127 | 1203 | 1420 |
| 133 | 108 | 4 | 3,6 | 127 | 855 | 1009 |

| DN1 | DN2 | S1 | S2 | L | Без ДДВ | Со ДДВ |
|-------|-------|-----|-----|-----|---------|-------------|
| мм | мм | мм | мм | мм | ден/пар | ден/пар |
| 133 | 114,3 | 4 | 3,6 | 127 | 859 | 1014 |
| 139,7 | 76,1 | 4 | 2,9 | 127 | 1344 | 1586 |
| 139,7 | 88,9 | 4 | 3,2 | 127 | 1142 | 1348 |
| 139,7 | 101,6 | 4 | 3,6 | 127 | 1111 | 1311 |
| 139,7 | 108 | 4 | 3,6 | 127 | 961 | 1134 |
| 139,7 | 114,3 | 4 | 3,6 | 127 | 861 | 1016 |
| 139,7 | 133 | 4 | 4 | 127 | 816 | 963 |
| 159 | 88,9 | 4,5 | 3,2 | 140 | 1919 | 2264 |
| 159 | 101,6 | 4,5 | 3,6 | 140 | 1579 | 1863 |
| 159 | 108 | 4,5 | 3,6 | 140 | 1359 | 1604 |
| 159 | 114,3 | 4,5 | 3,6 | 140 | 1225 | 1446 |
| 159 | 133 | 4,5 | 4 | 140 | 1032 | 1218 |
| 159 | 139,7 | 4,5 | 4 | 140 | 1033 | 1219 |
| 168,3 | 88,9 | 4,5 | 3,2 | 140 | 1940 | 2289 |
| 168,3 | 101,6 | 4,5 | 3,6 | 140 | 1728 | 2039 |
| 168,3 | 108 | 4,5 | 3,6 | 140 | 1589 | 1875 |
| 168,3 | 114,3 | 4,5 | 3,6 | 140 | 1271 | 1500 |
| 168,3 | 133 | 4,5 | 4 | 140 | 1093 | 1290 |
| 168,3 | 139,7 | 4,5 | 4 | 140 | 1099 | 1297 |
| 168,3 | 159 | 4,5 | 4,5 | 140 | 1108 | 1307 |
| 219,1 | 114,3 | 6,3 | 3,6 | 152 | 3078 | 3632 |
| 219,1 | 133 | 6,3 | 4 | 152 | 2378 | 2806 |
| 219,1 | 139,7 | 6,3 | 4 | 152 | 2024 | 2388 |
| 219,1 | 159 | 6,3 | 4,5 | 152 | 1951 | 2302 |
| 219,1 | 168,3 | 6,3 | 4,5 | 153 | 1970 | 2325 |
| 273 | 159 | 6,3 | 4 | 178 | 4723 | 5573 |
| 273 | 168,3 | 6,3 | 4,5 | 178 | 3809 | 4495 |
| 273 | 219,1 | 6,3 | 6,3 | 178 | 3240 | 3823 |
| 323,9 | 219,1 | 7,1 | 6,3 | 178 | 6813 | 8039 |
| 323,9 | 273 | 7,1 | 6,3 | 178 | 6114 | 7215 |

*цените се во денари

*го задржуваме правото на измени без обврска кон клиентите

15.01.2019

FLITING ZA ZAVARUVAWE PO ANSI B.16.9 STD
MATERIALI: ASTM A234 SERTIFIKAT: DIN 50049/3.1.B

| ND, inch | KONCEN. REDUCIR | | EKSCENT. REDUCIR | | TE[TIK REDUCIR | | ND, inch | KONCEN. REDUCIR | | EKSCENT. REDUCIR | | TE[TIK REDUCIR | |
|---------------|-----------------|-----|------------------|--|----------------|--|-----------|-----------------|------|------------------|--|----------------|--|
| | | | | | | | | | | | | | |
| 3/4 X 1/2 | 60 | 71 | | | | | 4 X 11/2 | 465 | 549 | | | | |
| 1 X 1/2 | 51 | 60 | | | | | 4 X 2 | 503 | 594 | | | | |
| 1 X 3/4 | 47 | 55 | | | | | 4 X 2 1/2 | 443 | 523 | | | | |
| 1 1/4 X 1/2 | 80 | 94 | | | | | 4 X 3 | 394 | 465 | | | | |
| 1 1/4 X 3/4 | 89 | 105 | | | | | 4 X 3 1/2 | | | | | | |
| 1 1/4 X 1 | 68 | 80 | | | | | 5 X 2 | 833 | 983 | | | | |
| 1 1/2 X 1/2 | 138 | 163 | | | | | 5 X 2 1/2 | 1257 | 1483 | | | | |
| 1 1/2 X 3/4 | 108 | 127 | | | | | 5 X 3 | 743 | 877 | | | | |
| 1 1/2 X 1 | 84 | 99 | | | | | 5 X 3 1/2 | | | | | | |
| 1 1/2 X 1 1/4 | 143 | 169 | | | | | 5 X 4 | 679 | 801 | | | | |
| 2 X 1/2 | 218 | 257 | | | | | 6 X 2 | 1301 | 1535 | | | | |
| 2 X 3/4 | 135 | 159 | | | | | 6 X 2 1/2 | 1103 | 1302 | | | | |
| 2 X 1 | 125 | 148 | | | | | 6 X 3 | 1553 | 1833 | | | | |
| 2 X 1 1/4 | 123 | 145 | | | | | 6 X 3 1/2 | | | | | | |
| 2 X 1 1/2 | 288 | 340 | | | | | 6 X 4 | | | | | | |
| 2 1/2 X 1 | 428 | 505 | | | | | 6 X 5 | 895 | 1056 | | | | |
| 2 1/2 X 1 1/4 | 246 | 290 | | | | | 8 X 3 | 1721 | 2031 | | | | |
| 2 1/2 X 1 1/2 | 355 | 419 | | | | | 8 X 4 | 1609 | 1899 | | | | |
| 2 1/2 X 2 | 199 | 235 | | | | | 8 X 5 | 1520 | 1794 | | | | |
| 3 X 1 | 337 | 398 | | | | | 8 X 6 | 1951 | 2302 | | | | |
| 3 X 1 1/4 | 324 | 382 | | | | | 10 X 4 | 2986 | 3523 | | | | |
| 3 X 1 1/2 | 302 | 356 | | | | | 10 X 5 | 2936 | 3464 | | | | |
| 3 X 2 | 273 | 322 | | | | | 10 X 6 | 2790 | 3292 | | | | |
| 3 X 2 1/2 | 392 | 463 | | | | | 10 X 8 | 2545 | 3003 | | | | |
| 3 1/2 X 1 1/2 | | | | | | | 12 X 6 | 4177 | 4929 | | | | |
| 3 1/2 X 2 | | | | | | | 12 X 8 | 3970 | 4685 | | | | |
| 3 1/2 X 2 1/2 | | | | | | | 12 X 10 | 3504 | 4135 | | | | |
| 3 1/2 X 3 | | | | | | | | | | | | | |

PROIZVODI TEL: RACORDERIE METALLICHE SPA, ITALIJA
 UVOZNI K: METALTERM DOO, SKOPJE, MAKEDONIJA

*цените се во денари

*го задржуваме правото на измени без обврска кон клиентите

14.09.2012

BEZRABEN FI TI NG ZA ZAVARUVAWE

FI TI NG ZA ZAVARUVAWE PO **ANSI B.16.9 STD**
 MATERI JAL: **ASTM A234 SERTI FI KAT: DIN 50049/3.1.B**
 CENA денари без и SO DDV, PAR^E

| ND, inch | NADVORE[EN DI JAMETAR | DEBELI NA NA YI DOT | KOLENO | | TE[TI K | | KAPA | |
|----------|---------------------------|------------------------|---------|--------|----------|--------|---------|--------|
| | | | без DDV | со ДДВ | без DDV | со ДДВ | без DDV | со ДДВ |
| 1/2" | 21,34 | 2,77 | 45 | 53 | 80 | 94 | | |
| 3/4" | 26,67 | 2,87 | 51 | 60 | 107 | 126 | | |
| 1" | 33,40 | 3,38 | 79 | 94 | | | 41 | 48 |
| 1 1/4" | 42,16 | 3,56 | 90 | 107 | 168 | 198 | 56 | 66 |
| 1 1/2" | 48,26 | 3,68 | 132 | 156 | 236 | 278 | 62 | 73 |
| 2" | 60,33 | 3,91 | 176 | 208 | | | 78 | 92 |
| 2 1/2" | 73,03 | 5,16 | 328 | 387 | 556 | 656 | 142 | 168 |
| 3" | 88,90 | 5,49 | 490 | 578 | 1067 | 1259 | 191 | 225 |
| 3 1/2" | 101,60 | 5,74 | 607 | 716 | | | | |
| 4" | 114,30 | 6,02 | 851 | 1004 | 1248 | 1473 | 297 | 350 |
| 5" | 141,30 | 6,55 | 1363 | 1608 | 2010 | 2372 | 561 | 662 |
| 6" | 168,28 | 7,11 | 2132 | 2516 | 2769 | 3267 | 752 | 887 |
| 8" | 219,08 | 8,18 | 4007 | 4728 | 4709 | 5557 | 1449 | 1710 |
| 10" | 273,05 | 9,27 | 7197 | 8493 | 7182 | 8475 | 1760 | 2077 |
| 12" | 323,85 | 9,53 | 10530 | 12425 | 9759 | 11516 | 2072 | 2445 |



PROI ZVODI TEL: **RACORDERIE METALLICHE SPA**, I TALI JA
 UVOZNI K: **METALTERM DOO**, SKOPJE, MAKEDONI JA

*цените се во денари

*го задржуваме правото на измени без обврска кон клиентите

01.01.2015

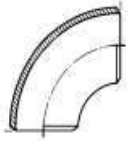
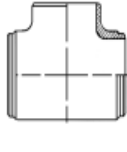
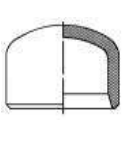
FITING ZA ZAVARUVAWE PO ANSI B.16.9 XS
MATERIAL: ASTM A234 SERTIFIKAT: DIN 50049/3.1.B
PO BARAVE

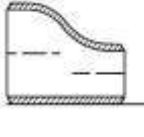
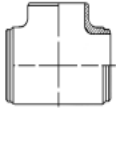
| ND, inch | DEBELI NA NA YI DOT |  |  |  | ND, inch |  |  |  |
|----------|------------------------|---|---|---|---------------|---|---|---|
| 1/2" | 3,73 | | | | 3/4 X 1/2 | | | |
| 3/4" | 3,91 | | | | 1 X 1/2 | | | |
| 1" | 4,55 | | | | 1X3/4 | | | |
| 1 1/4" | 4,85 | | | | 1 1/4 X 1/2 | | | |
| 1 1/2" | 5,08 | | | | 1 1/4 X 3/4 | | | |
| 2" | 5,54 | | | | 1 1/4 X 1 | | | |
| 2 1/2" | 7,01 | | | | 1 1/2 X 1 | | | |
| 3" | 7,62 | | | | 1 1/2 X 1 1/4 | | | |
| 3 1/2" | 8,08 | | | | 2 X 1 | | | |
| 4" | 8,56 | | | | 2 X 1 1/4 | | | |
| 5" | 9,53 | | | | 2 X 1 1/2 | | | |
| 6" | 10,97 | | | | 2 1/2 X 1 1/2 | | | |
| 8" | 12,70 | | | | 2 1/2 X 2 | | | |
| 10" | 12,70 | | | | 3 X 1 1/2 | | | |
| 12" | 12,70 | | | | 3 X 2 | | | |
| 14" | 12,70 | | | | 3 X 2 1/2 | | | |
| 16" | 12,70 | | | | 4 X 2 | | | |
| 18" | 12,70 | | | | 4 X 2 1/2 | | | |
| | | | | | 4 X 3 | | | |
| | | | | | 5 X 2 | | | |
| | | | | | 5 X 2 1/2 | | | |
| | | | | | 5 X 3 | | | |
| | | | | | 5 X 4 | | | |
| | | | | | 6 X 2 1/2 | | | |
| | | | | | 6 X 3 | | | |
| | | | | | 6 X 4 | | | |
| | | | | | 6 X 5 | | | |
| | | | | | 8 X 4 | | | |
| | | | | | 8 X 5 | | | |
| | | | | | 8 X 6 | | | |
| | | | | | 10 X 4 | | | |
| | | | | | 10 X 5 | | | |
| | | | | | 10 X 6 | | | |
| | | | | | 10 X 8 | | | |
| | | | | | 12 X 6 | | | |
| | | | | | 12 X 8 | | | |
| | | | | | 12 X 10 | | | |

PROIZVODI TEL: RACORDERIE METALLICHE SPA, ITALIJA
 UVOZNI K: METALTERM DOO, SKOPJE, MAKEDONIJA

*цените се во денари

*го задржуваме правото на измени без обврска кон клиентите

CRNA RABNA CEVKA **DIN 2440**

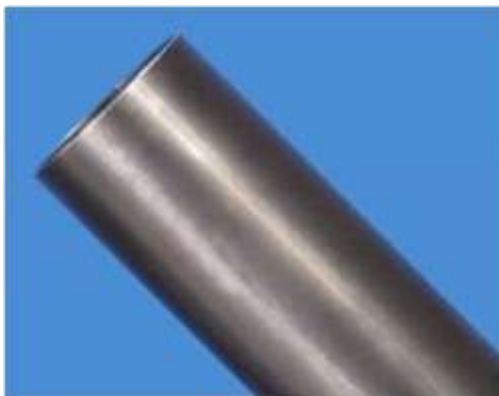

| CRNA RABNA CEVKA DIN 2440 | | | |
|----------------------------------|--------------|--------------|-------------|
| DI MENZI JA | EDI N. MERKA | CENA БЕЗ DDV | CENA SO DDV |
| 3/8" | MTR. | 51 | 60 |
| 1/2" | MTR. | 57 | 67 |
| 3/4" | MTR. | 75 | 89 |
| 1" | MTR. | 114 | 134 |
| 1 1/4" | MTR. | 147 | 173 |
| 1 1/2" | MTR. | 206 | 243 |
| 2" | MTR. | 208 | 246 |
| 2 1/2" | MTR. | 308 | 363 |
| 3" | MTR. | 427 | 504 |
| 4" | MTR. | | |

FITING OD ^ELIK

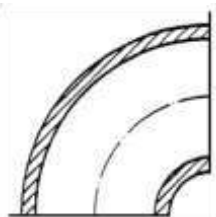
CRNO KOLENO: R = 1.5 D
STANDARD: DIN 2605
MATERIALI: ST.37 - ^.1212
POTEKLO: ITALIJA
LEGENDA:
S - DEBELINA NA YI DOT
D - NADVORE[EN DI JAMETAR
ND - NOMI NALENDI JAMETAR

| ND, inch | D, mm | S, mm | kg / парче | Pakuvawe | Cena/par. bez ddv | Cena / par.so ddv |
|----------|-------|-------|------------|----------|-------------------|-------------------|
| 1/2" | 21.3 | 2.0 | 0.04 | 100 | 94 | 103 |
| 3/4" | 26.9 | 2.3 | 0.07 | 100 | 51 | 62 |
| 1" | 33.7 | 2.6 | 0.12 | 80 | 59 | 70 |
| 5/4" | 38.0 | 2.6 | 0.16 | 80 | 94 | 111 |
| 5/4" | 42.4 | 2.6 | 0.19 | 50 | 71 | 84 |
| 6/4" | 44.5 | 2.6 | 0.22 | 50 | | |
| 6/4" | 48.3 | 2.6 | 0.27 | 50 | 79 | 93 |
| 6/4" | 51.0 | 2.6 | 0.33 | 50 | | |
| 2" | 57.0 | 2.9 | 0.44 | 25 | 150 | 177 |
| 2" | 60.3 | 2.9 | 0.49 | 25 | 128 | 151 |
| 2" | 63.5 | 2.9 | 0.58 | 5 | | |
| 2 1/2" | 70.0 | 2.9 | 0.70 | 5 | 207 | 244 |
| 2 1/2" | 76.1 | 2.9 | 0.79 | 5 | 186 | 219 |
| 3" | 88.9 | 3.2 | 1.22 | 5 | 267 | 315 |
| 3 1/2" | 101.6 | 3.6 | 1.83 | 4 | 453 | 535 |
| 4" | 108.0 | 3.6 | 2.08 | 4 | 486 | 573 |
| 4" | 114.3 | 3.6 | 2.37 | 4 | 515 | 608 |
| 5" | 133.0 | 4.0 | 3.64 | 3 | 712 | 840 |
| 5" | 139.7 | 4.0 | 4.04 | 3 | 873 | 1030 |
| 6" | 159.0 | 4.5 | 5.90 | 3 | 1093 | 1290 |
| 6" | 168.3 | 4.5 | 6.50 | 1 | 1508 | 1780 |
| 8" | 219.1 | 6.3 | 14.90 | 1 | 2797 | 3300 |
| 10" | 273.0 | 6.3 | 24.90 | 1 | 7034 | 8300 |
| 12" | 323.9 | 7.1 | 40.00 | 1 | 10593 | 12500 |

CRN MUF
STANDARD: DIN 2605
MATERIALI:
ST.37 - ^.1212
POTEKLO: ITALIJA

| ND, inch | S, mm | Pakuvawe | Cena/par. bez ddv | Cena / par.so ddv | ЦРН МУФ НАВОЈ/ ЗАВАРУВАЊЕ | ЦРН МУФ НАВОЈ/ ЗАВАРУВАЊЕ |
|----------|-------|----------|-------------------|-------------------|------------------------------|---------------------------------|
| | | | | | ЦЕНА БЕЗ ДДВ | ЦЕНА СО ДДВ |
| 3/8" | 2.35 | 150 | 21 | 25 | | |
| 1/2" | 2.65 | 150 | 33 | 39 | 41 | 48 |
| 3/4" | 2.65 | 150 | 37 | 44 | 43 | 51 |
| 1" | 3.25 | 10 | 74 | 87 | 46 | 54 |
| 5/4" | 3.25 | 50 | 77 | 91 | 50 | 59 |
| 6/4" | 3.25 | 40 | 101 | 119 | 77 | 91 |
| 2" | 3.65 | 25 | 136 | 160 | 127 | 150 |
| 2 1/2" | 3.65 | 1 | 216 | 255 | 220 | 260 |
| 3" | 4.05 | 1 | 278 | 328 | 183 | 330 |
| 4" | 4.50 | 1 | 565 | 667 | | |

*цените се во денари

*го задржуваме правото на измени без обврска кон клиентите

30/05/2018

VENTILI SO PRI RABNICI PO DIN

| DN | [I BER PLOSNAT F4 PN 10/16 | | [I BER PLOSNAT F4 PN 10 | | [I BER PLOSNAT F5 PN 16 | | F I L T E R PN 16 | |
|-----|---|-------------|---|-------------|--|-------------|---|-------------|
| | Цени без ддв | Цени со ддв | Цени без ддв | Цени со ддв | Цени без ддв | Цени со ддв | Цени без ддв | Цени со ддв |
| 15 | | | | | | | 857 | 1011 |
| 20 | | | | | | | 1074 | 1267 |
| 25 | | | | | | | 1380 | 1628 |
| 32 | | | | | | | 1857 | 2191 |
| 40 | 3763 | 4440 | | | 4407 | 5200 | 2103 | 2482 |
| 50 | 4147 | 4893 | | | 5181 | 6114 | 2864 | 3380 |
| 65 | 5071 | 5984 | | | 6013 | 7095 | 3973 | 4688 |
| 80 | 5831 | 6881 | | | 6834 | 8064 | 4713 | 5561 |
| 100 | 7500 | 8850 | | | 8620 | 10172 | 6786 | 8007 |
| 125 | 11850 | 13983 | | | 12563 | 14824 | 10853 | 12807 |
| 150 | 13978 | 16494 | | | 15000 | 17700 | 14215 | 16774 |
| 200 | | | 26750 | 31565 | 29961 | 35354 | 23575 | 27819 |
| 250 | | | 43835 | 51725 | 48286 | 56977 | 45033 | 53139 |
| 300 | | | 64223 | 75783 | 70646 | 83362 | 62568 | 73830 |
| |  | |  | |  | |  | |

| DN | RAMEN ZAPOREN PN 16 | | TOP^EST PN 16 | | НЕПОВРАТЕН СО КЛАПНА PN 16 SWING | | НЕПОВРАТЕН СО ТЕГ PN 16 | |
|-----|---|-------------|---|-------------|--|-------------|----------------------------|-------------|
| | Цени без ддв | Цени со ддв | Цени без ддв | Цени со ддв | Цени без ддв | Цени со ддв | Цени без ддв | Цени со ддв |
| 15 | 1582 | 1867 | 2516 | 2969 | | | 1550 | 1829 |
| 20 | 1819 | 2146 | 2803 | 3308 | | | 1783 | 2104 |
| 25 | 2308 | 2723 | 3226 | 3807 | | | 2262 | 2669 |
| 32 | 3238 | 3821 | 3440 | 4059 | | | 3036 | 3582 |
| 40 | 4111 | 4851 | 3793 | 4476 | 3838 | 4529 | 3864 | 4560 |
| 50 | 5519 | 6512 | 4498 | 5308 | 4471 | 5276 | 5188 | 6122 |
| 65 | 6610 | 7800 | 6231 | 7353 | 6097 | 7194 | 6307 | 7442 |
| 80 | 9431 | 11129 | 8226 | 9707 | 6935 | 8183 | 8959 | 10572 |
| 100 | 12205 | 14402 | 11084 | 13079 | 8756 | 10332 | 11845 | 13977 |
| 125 | 19530 | 23045 | 19002 | 22423 | 13827 | 16316 | 18782 | 22163 |
| 150 | 25784 | 30425 | 29212 | 34470 | 19026 | 22451 | 24787 | 29249 |
| 200 | 46153 | 54461 | 51482 | 60749 | 33148 | 39115 | 43937 | 51846 |
| 250 | 90999 | 107379 | | | 52604 | 62073 | | |
| 300 | 145059 | 171170 | | | | | | |
| |  | |  | |  | | | |

Uvozni k: Metal term DOO

 Proizvodi tel : *UMB - Romania, Duyar Vana, Polix*

*цените се во денари

*го задржуваме правото на измени без обврска кон клиентите

24.07.2017

VENTIL TIPI "LEPTIR"

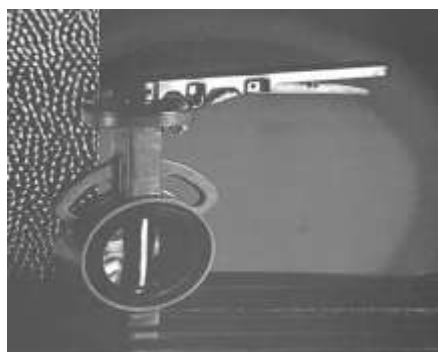

| DIMENZIJA | CENA VO DENARI | | | | | | | | | |
|-----------|----------------|-------------|--------------|-------------|--------------|-------------------|--------------|-------------|--------------|-------------|
| | DISKODSILIV | | | | | DISKINOX AISI 316 | | | | |
| | DUYAR | | belven | | sferaco | belven | | sferaco | | |
| | Цени без ддв | Цени со ддв | Цени без ддв | Цени со ддв | Цени без ддв | Цени со ддв | Цени без ддв | Цени со ддв | Цени без ддв | Цени со ддв |
| 2" | 1594 | 1881 | 3370 | 3977 | 1491 | 1759 | 3846 | 4538 | 1914 | 2259 |
| 2 1/2" | 1766 | 2084 | 3370 | 3977 | 1690 | 1994 | 4361 | 5146 | 2245 | 2649 |
| 3" | 1999 | 2359 | 3917 | 4622 | 1884 | 2223 | 4678 | 5520 | 2574 | 3037 |
| 4" | 2767 | 3265 | 4520 | 5334 | 2397 | 2828 | 5749 | 6784 | 3748 | 4423 |
| 5" | 3293 | 3886 | 5313 | 6269 | 3174 | 3745 | 6859 | 8094 | 4933 | 5821 |
| 6" | 3902 | 4604 | 6066 | 7158 | 3772 | 4451 | 7374 | 8701 | 6418 | 7573 |
| 8" | 7581 | 8946 | 9475 | 11181 | 5942 | 7012 | 11854 | 13988 | 10159 | 11988 |
| 10" | 10018 | 11821 | 14769 | 17427 | 10000 | 11800 | 21211 | 25029 | 16358 | 19302 |
| 12" | 11848 | 13981 | 19169 | 22619 | 12793 | 15096 | 31261 | 36888 | 24456 | 28858 |

Uvozni k: Metal term DOO

Proizvodi tel : Belven, Sferaco, Duyar Vana

ЧЕЛИЧЕН ТОПЧЕСТ ВЕНТИЛ НА ЗАВАРУВАЊЕ ЗА ВОДА PN 25/40 T -30+200*°C

| ДИМЕНЗИЈА | ЦЕНА БЕЗ ДДВ | ЦЕНА СО ДДВ |
|-----------|--------------|-------------|
| 15 | 1129 | 1332 |
| 20 | 1292 | 1525 |
| 25 | 1659 | 1958 |
| 32 | 2030 | 2395 |
| 40 | 2896 | 3417 |
| 50 | 3396 | 4007 |
| 65 | 4993 | 5892 |
| 80 | 6656 | 7854 |
| 100 | 9506 | 11217 |
| 125 | 15714 | 18543 |
| 150 | 21859 | 25794 |
| 200 | 45954 | 54226 |



*цените се во денари

*го задржуваме правото на измени без обврска кон клиентите

24.07.2017

КОНДЕНЗНИ ЛОНЧИЊА

МАТЕРИЈАЛ

| | |
|------------|--------|
| ТЕЛО | ГУСЕН |
| КАПАК/ТАПА | ГУСЕН |
| НАСЕД | SS 410 |
| ДИСК | SS 304 |
| ЗАПТИВКА | PTFE |
| ФИЛТЕР | SS 304 |

Термодинамички тип

Притисок на испитување: Тело 32 bar (Хидростатично)

Работен притисок: 0,3 bar – 16 bar

Температура: 220°C

КАПАЦИТЕТ (кг/час)

| P BAR | 0,3 | 0,6 | 1 | 2 | 3 | 4 | 5 | 6 | 8 | 10 | 12 | 14 | 16 |
|---------|-----|-----|-----|-----|------|------|------|------|------|------|------|------|------|
| 15 – 25 | 183 | 220 | 253 | 330 | 345 | 385 | 420 | 450 | 510 | 570 | 630 | 680 | 740 |
| 32 | 350 | 410 | 490 | 620 | 730 | 820 | 900 | 960 | 1080 | 1200 | 1320 | 1440 | 1560 |
| 40 | 440 | 520 | 610 | 780 | 900 | 1000 | 1090 | 1180 | 1350 | 1500 | 1650 | 1790 | 1930 |
| 50 | 460 | 560 | 670 | 850 | 1000 | 1110 | 1220 | 1320 | 1500 | 1680 | 1860 | 2030 | 2200 |

ST-T3F Фланши

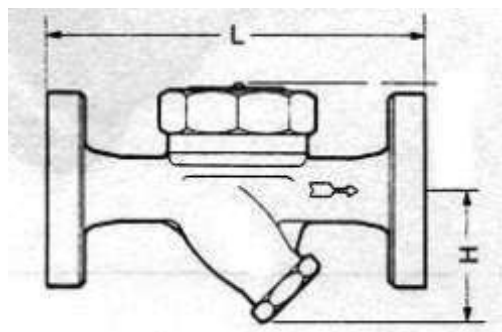

| ДУ | цол | 1/2 | 3/4 | 1 | 1 1/4 | 1 1/2 | 2 |
|---------------------|-----|-------------|-------------|-------------|-------------|-------------|--------------|
| | мм | 15 | 20 | 25 | 32 | 40 | 50 |
| L (мм) | | 142 | 160 | 182 | 244 | 244 | 268 |
| H (мм) | | 67 | 73 | 92 | 107 | 107 | 125 |
| ЦЕНА БЕЗ ДДВ | | 3417 | 3616 | 4283 | 6923 | 7312 | 12549 |
| ЦЕНА СО ДДВ | | 4032 | 4267 | 5054 | 8169 | 8628 | 14808 |

Димензии на фланшите – по DIN

ST-T3A Навој

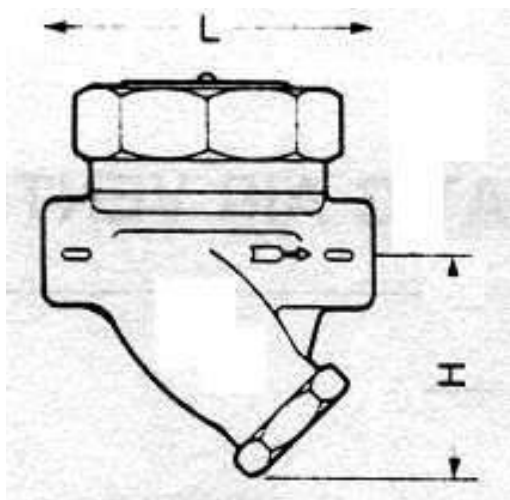

| ДУ | цол | 1/2 | 3/4 | 1 | 1 1/4 | 1 1/2 | 2 |
|---------------------|-----|-------------|-------------|-------------|-------------|-------------|-------------|
| | мм | 15 | 20 | 25 | 32 | 40 | 50 |
| L (мм) | | 67 | 105 | 112 | 173 | 187 | 203 |
| H (мм) | | 54 | 56 | 61 | 87 | 92 | 101 |
| ЦЕНА БЕЗ ДДВ | | 2302 | 2391 | 2505 | 5432 | 5567 | 6898 |
| ЦЕНА СО ДДВ | | 2716 | 2821 | 2956 | 6410 | 6569 | 8140 |

Димензии на навојот – по BS21, ANSI B2.1 или DIN 259

ПРОИЗВОДИТЕЛ: 317 LTD., ТАЈВАН
 УВОЗНИК: МЕТАЛТЕРМ ДОО, СКОПЈЕ

*цените се во денари

*го задржуваме правото на измени без обврска кон клиентите

15.01.2019





НЕПОВРАТНИ КЛАПНИ

| | | | | | |
|--|--|---|--|--|---|
| Двоен диск Тело: гус Диск: гус Заптивање: EPDM РУ 16, Т 110°C  05 | Еднодисков Тело: инокс 304/316 Диск: инокс 304/316 Заптивање: метал/метал РУ 40, Т 200°C  | Еднодисков Заптивање: метал/метал РУ 16, Т 120°C Тело: месинг Диск: инокс 304  | Еднодисков Заптивање: метал/метал РУ 16, Т 120°C Тело: гус Диск: гус  | Тип Мигалка Тело: железо Диск: железо Заптивање: EPDM/NBR РУ 16, Т 110°C  | Тип Мигалка Тело: 316/316L Диск: 316/316L Заптивање: FKM РУ 16, Т 180°C  |
|--|--|---|--|--|---|

| ДИМЕНЗИЈА ДН | ЦЕНА СО ДДВ | ЦЕНА СО ДДВ | ЦЕНА СО ДДВ | ЦЕНА СО ДДВ | ЦЕНА СО ДДВ | |
|-----------------|-------------|-----------------------------------|-------------|-------------|-------------|---------------------------|
| 15 | | 1391 | 1043 | | | |
| 20 | | 1769 | 1238 | | | |
| 25 | | 2243 | 1334 | | | |
| 32 | | 2982 | 1841 | | | |
| 40 | | 3744 | 2101 | | 1155 | |
| 50 | 1222 | 5413 | 3089 | | 1251 | |
| 65 | 1497 | 8503 | 4112 | | 1460 | |
| 80 | 1958 | 11934 | 5148 | | 1770 | |
| 100 | 2461 | 14318 | 7210 | | 2319 | |
| 125 | 3075 | По барање димензии ДН125—ДН600 | | 10671 | 3117 | Димензии: ДН40 - ДН600 |
| 150 | 4096 | | | 13937 | 3815 | |
| 200 | 7000 | | | 20140 | 6125 | |
| 250 | 8927 | | | | 9694 | |
| 300 | 14277 | | | | 15552 | |
| 350 | 26452 | | | | | |
| 400 | 90657 | | | | | |
| 450 | 129959 | | | | | |
| 500 | 153328 | | | | | |

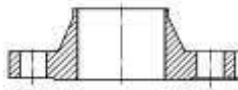
^ELI ^NI FLAN[I PO DIN

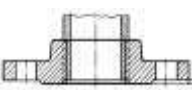
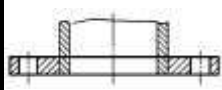

| DI - MENZI JA | DIN 2633/PN 16 SO GRLO | | DIN 2635/PN 40 SO GRLO | | DIN 2527/PN10 SLEPA | | DIN 2566/PN16 SO NAVOJ | | DIN 2576/PN 10 RAMNA | | DIN 2576/PN 16 RAMNA | |
|---------------------|---|--------|---|--------|---|--------|--|--------|---|--------|---|--------|
| |  | |  | |  | |  | |  | |  | |
| | без ДДВ | со ДДВ | без ДДВ | со ДДВ | без ДДВ | со ДДВ | без ДДВ | со ДДВ | без ДДВ | со ДДВ | без ДДВ | со ДДВ |
| 1/2" | 276 | 326 | 348 | 411 | 158 | 186 | 155 | 183 | 102 | 120 | 168 | 198 |
| 3/4" | 325 | 383 | 372 | 439 | 266 | 314 | 386 | 456 | 113 | 133 | 180 | 212 |
| 1" | 329 | 388 | 407 | 480 | 290 | 342 | 445 | 525 | 141 | 166 | 204 | 241 |
| 1 1/4" | 484 | 571 | 556 | 656 | 395 | 466 | 470 | 555 | 186 | 219 | 312 | 368 |
| 1 1/2" | 531 | 627 | 677 | 799 | 447 | 528 | 496 | 585 | 237 | 280 | 354 | 418 |
| 2" | 677 | 799 | 809 | 955 | 472 | 557 | 611 | 721 | 305 | 360 | 426 | 503 |
| 2 1/2" | 822 | 970 | 1,026 | 1,211 | 617 | 728 | 864 | 1,019 | 360 | 425 | 540 | 637 |
| 3" | 930 | 1,097 | 1,208 | 1,425 | 758 | 895 | 979 | 1,155 | 465 | 549 | 642 | 758 |
| 4" | 1,159 | 1,368 | 2,270 | 2,679 | 942 | 1,111 | 1,073 | 1,266 | 489 | 577 | 714 | 843 |
| 5" | 1,570 | 1,853 | 2,803 | 3,307 | 1,401 | 1,653 | 1,201 | 1,417 | 723 | 853 | 960 | 1133 |
| 6" | 1,933 | 2,281 | 2,971 | 3,506 | 1,739 | 2,052 | 2,077 | 2,451 | 778 | 918 | 1200 | 1416 |
| 8" | 3,188 | 3,762 | 6,256 | 7,382 | 2,754 | 3,250 | | | 1222 | 1442 | 1897 | 2238 |
| 10" | 5,826 | 6,875 | 10,119 | 11,941 | 4,348 | 5,131 | | | 1525 | 1800 | 2388 | 2818 |
| 12" | | | 13,960 | 16,473 | 5,482 | 6,469 | | | 1819 | 2146 | 2606 | 3075 |

ELEMENTI ZA SPOJUVAWE NA PRI RABNICI

ZAPTI VEN ELEMENT - DIHTUNG OD KLINGERIT

RABOTNA TEMPERATURA: DO 300°C

DEBELINA: 2 - 4 mm VO ZAVISNOST OD NO

DIMENZIJI SOGLASNO DIN 2690

OD NO 15 DO NO 300



| DI MENZIJA | CENA/PAR^E BEZ DDV | CENA/PAR^E SO DDV |
|------------|-----------------------|----------------------|
| 15 | 19 | 22 |
| 20 | 25 | 30 |
| 25 | 28 | 33 |
| 32 | 45 | 53 |
| 40 | 52 | 61 |
| 50 | 76 | 90 |
| 65 | 108 | 128 |
| 80 | 114 | 134 |
| 100 | 127 | 150 |
| 125 | 242 | 286 |
| 150 | 303 | 357 |
| 200 | | |
| 250 | | |
| 300 | | |

MA[INSKI ZAVRTKI I NAVRTKI

KVALITET: 5.6 DO NP 16, CRNI I ICIKANI

| ZAVRTKI | | |
|-----------------|---------------------------|--------------------------|
| DI MEN- ZIJA | CENA/ PAR^E BEZ DDV | CENA/ PAR^E SO DDV |
| M 12 / 50 | 13 | 15 |
| M 16 / 60 | 31 | 36 |
| M 16 / 70 | 32 | 38 |

| NAVRTKI | | |
|-----------------|---------------------------|--------------------------|
| DI MEN- ZIJA | CENA/ PAR^E BEZ DDV | CENA/ PAR^E SO DDV |
| M 12 | 6 | 7 |
| M 16 | 10 | 12 |

 LEGENDA: **L** - AKTI VNA DOLINA NA ZAVRTKATA

M - NAVOJ

n - BROJ NA DUPKI

| NO | NP 6 | | | NP 10 | | | NP 16 | | | NP 25/40 | | |
|-----|------|----|---|-------|----|---|-------|----|---|----------|----|---|
| | L | M | n | L | M | n | L | M | n | L | M | n |
| 15 | 40 | 10 | 4 | 45 | 12 | 4 | 45 | 12 | 4 | 50 | 12 | 4 |
| 20 | 45 | 10 | 4 | 50 | 12 | 4 | 50 | 12 | 4 | 50 | 12 | 4 |
| 25 | 45 | 10 | 4 | 50 | 12 | 4 | 50 | 12 | 4 | 50 | 12 | 4 |
| 32 | 45 | 12 | 4 | 50 | 16 | 4 | 50 | 16 | 4 | 55 | 16 | 4 |
| 40 | 45 | 12 | 4 | 50 | 16 | 4 | 50 | 16 | 4 | 55 | 16 | 4 |
| 50 | 45 | 12 | 4 | 55 | 16 | 4 | 55 | 16 | 4 | 60 | 16 | 4 |
| 65 | 45 | 12 | 4 | 55 | 16 | 4 | 55 | 16 | 4 | 65 | 16 | 8 |
| 80 | 60 | 16 | 4 | 60 | 16 | 4 | 60 | 16 | 8 | 70 | 16 | 8 |
| 100 | 60 | 16 | 8 | 60 | 16 | 8 | 60 | 16 | 8 | 70 | 20 | 8 |
| 125 | 60 | 16 | 8 | 65 | 16 | 8 | 65 | 16 | 8 | 80 | 24 | 8 |
| 150 | 60 | 16 | 8 | 65 | 20 | 8 | 65 | 20 | 8 | 90 | 24 | 8 |

*цените се во денари

*го задржуваме правото на измени без обврска кон клиентите

DI LATACI ONI KOMPENZATORI

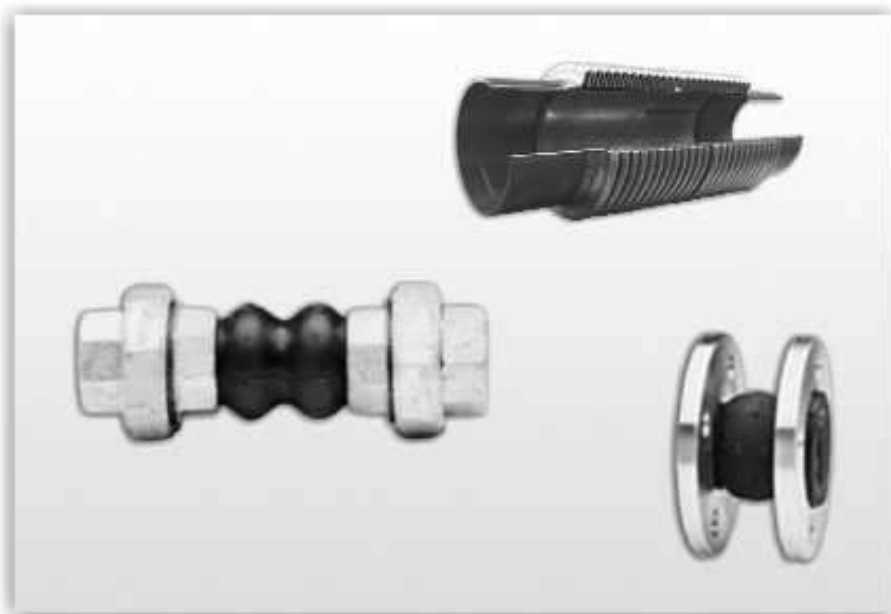

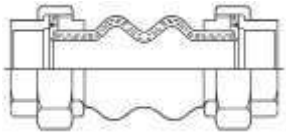
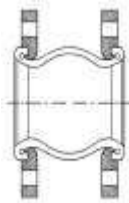
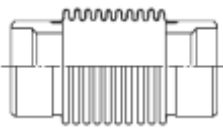
| DI MENZI JA | GUMEN KOMPENZATOR SO HOLEN- DERI | | GUMEN KOMPENZATOR SO PRI RABNI CI | | | | KOMPENZATOR SO ZAVARU- VAWE | |
|-------------|---|--------|---|--------|---------|--------|---|--------|
| | без ДДВ | со ДДВ | PN10 | | PN16 | | без ДДВ | со ДДВ |
| | без ДДВ | со ДДВ | без ДДВ | со ДДВ | без ДДВ | со ДДВ | без ДДВ | со ДДВ |
| 1/2" | 874 | 1031 | | | | | | |
| 3/4" | 874 | 1031 | | | | | | |
| 1" | 1086 | 1281 | | | | | 2815 | 3322 |
| 1 1/4" | 1236 | 1458 | 1497 | 1766 | | | 3272 | 3861 |
| 1 1/2" | 1456 | 1718 | 1535 | 1811 | | | 3576 | 4220 |
| 2" | 1716 | 2025 | 1834 | 2164 | | | 3823 | 4511 |
| 2 1/2" | 2687 | 3171 | 2250 | 2655 | | | 5098 | 6016 |
| 3" | 3658 | 4316 | 2592 | 3059 | | | 5573 | 6576 |
| 4" | | | 3265 | 3853 | | | 7342 | 8664 |
| 5" | | | 3985 | 4702 | | | 9796 | 11559 |
| 6" | | | 5166 | 6096 | | | 11090 | 13086 |
| 8" | | | 7674 | 9055 | 9335 | 11016 | 15369 | 18135 |
| 10" | | | 11721 | 13831 | 12936 | 15265 | | |
| 12" | | | 15894 | 18755 | 17811 | 21017 | | |
| 14" | | | 21740 | 25653 | | | | |
| 16" | | | 25527 | 30122 | | | | |
| |  | |  | | | |  | |

El elektro - magneten ventili **TORK**



Proizvodi tel : **Tork**, Turcija
 Uvozni k: Metal term

Namena:
 Voda, vazduh, i neretni gasovi (azot, argon i dr.)

Temperatura:
 -10...+80°C

Napon:
 12 V AC/DC...220 V AC

| Tip | | Prikl u-ok | Светло сечение | KV | Pri ti sok | | Cena, Denari /par | |
|-------------------|----|------------|----------------|-----|------------|--------|-------------------|-------------|
| | | | | | mm | lt/min | min bar | max bar |
| T-GM 102 | H3 | 3/8" | 12 | 40 | 0,5 | 16 | 2105 | 2484 |
| T-GM 102A | HO | | | 40 | 0,5 | 16 | 2368 | 2795 |
| T-GM 103 | H3 | 1/2" | 14 | 45 | 0,5 | 16 | 2105 | 2484 |
| T-GM 103A | HO | | | 45 | 0,5 | 16 | 2368 | 2795 |
| T-GM 104 | H3 | 3/4" | 17 | 80 | 0,5 | 16 | 2544 | 3002 |
| T-GM 104A | HO | | | 80 | 0,5 | 16 | 2807 | 3312 |
| T-GM 105 | H3 | 1" | 17 | 80 | 0,5 | 16 | 2544 | 3002 |
| T-GM 105A | HO | | | 80 | 0,5 | 16 | 2807 | 3312 |
| T-GM 109 | H3 | 1 1/4" | 40 | 400 | 0,5 | 10 | 7019 | 8282 |
| T-GM 109A | HO | | | 400 | 0,5 | 10 | 7282 | 8592 |
| T-GM 106 | H3 | 1 1/2" | 40 | 400 | 0,5 | 10 | 7019 | 8282 |
| T-GM 106A | HO | | | 400 | 0,5 | 10 | 7282 | 8592 |
| T-GM 107 | H3 | 2" | 50 | 540 | 0,5 | 10 | 7896 | 9317 |
| T-GM 107A | HO | | | 540 | 0,5 | 10 | 8159 | 9627 |
| T-GM 102 N | H3 | 3/8" | 12 | 40 | 0,5 | 16 | 2456 | 2898 |
| T-GM 103 N | H3 | 1/2" | 14 | 45 | 0,5 | 16 | 2544 | 3002 |

bez indeks (T-GM 102) - H3 normal no zatvoren
 indeks "A" (T-GM 102A) - HO normal no otvoren
 indeks "N" (T-GM 102N) - za naf ta

Po nara-ka se i spora-uvaat: $t_{max} = 160^{\circ}C$, $P_{min} = 0$ bar, $P_{max} = 40$ bar, 3" и др.

*цените се во денари

*го задржуваме правото на измени без обврска кон клиентите

Spojki i Fitinzi Quikcoup

 Proizvodi tel : *Modgal, Израел* Uvozni k: Metal term DOO

| Oznaka | | Cena, denari /par~e, so DDV | | | | | | | | | | | | | |
|---|--|-----------------------------|-----|--------|-------|--------|-------|-------|-------|-------|-------|-------|-------|-------|-------|
| | | 1" | 1 | 1 1/2" | 2" | 2 1/2" | 3" | 108 | 4" | 133 | 5" | 159 | 165 | 6" | 8" |
|  | Fl eksi bi l na spojka Flexible coupling ST 75 | | 275 | 290 | 299 | 354 | 436 | 875 | 709 | 992 | 1.009 | 1.180 | 1.192 | 1.192 | 1.785 |
|  | Spojka Rigid coupling ST 75RT | | 286 | 299 | 312 | 367 | 452 | | 744 | | 1.058 | | 1.215 | 1.215 | 1.852 |
|  | Fl eksi bi l na spojka Quikhinge ST 007 | 254 | 254 | 251 | 263 | 291 | 316 | | 538 | | 927 | | 1.008 | 1.008 | |
|  | Spojka Quikhinge ST 007RT | | 254 | 254 | 254 | 254 | 254 | 254 | 254 | 254 | 254 | 254 | 254 | 254 | 254 |
|  | Kol eno 90° Quikbend ST 06 | | 316 | 307 | 307 | 503 | 604 | 1.135 | 1.085 | 2.138 | 1.815 | 2.656 | 2.578 | 2.661 | 4.683 |
|  | Kol eno 45° Quikbend ST 04 | | 316 | 307 | 307 | 503 | 604 | 1.135 | 1.085 | 2.138 | 1.815 | 2.656 | 2.578 | 2.661 | 4.683 |
|  | Te{ ti k Tee ST 05 | 440 | 488 | 494 | 494 | 741 | 958 | 1.722 | 1.520 | 3.333 | 2.942 | 4.361 | 3.679 | 3.610 | 6.956 |
|  | Fl an{ a Quikflange ST 90 | | | | 1.566 | 1.997 | 1.716 | | 2.104 | | 3.560 | | 3.875 | 3.875 | 4.629 |
|  | Kol eno 90° Kratok radi us Quikbend ST 66 | 140 | 316 | 305 | 305 | 438 | 556 | 1.295 | 777 | | 1.878 | | 2.398 | 2.295 | 4.185 |
|  | Te{ ti k Kratok radi us Tee ST 65 | 247 | 488 | 494 | 494 | 727 | 951 | 1.281 | 1.242 | | 2.939 | 3.432 | 3.673 | 3.273 | 6.169 |
|  | Kapa End-cap ST 02 | | 202 | 202 | 202 | 316 | 316 | 450 | 343 | 1.026 | 858 | 1.159 | 975 | 827 | 1.693 |

*цените се во денари

*го задржуваме правото на измени без обврска кон клиентите

04.04.2011

| Oznaka | 1" | 1 | 1 1/2" | 2" | 2 1/2" | 3" | 108 | 4" | 133 | 5" | 159 | 165 | 6" | 8" | |
|--|--|------|--------|-------|--------|-------|-------|-------|-------|-------|-------|-------|-------|-------|--|
| Reducir spojka ST 71  | 1 1/2" | | | 604 | | | | | | | | | | | |
| | 2" | | | | 839 | 961 | | 1.539 | | | | | | | |
| | 2 1/2" | | | | | 961 | | 1.539 | | | | | | | |
| | 3" | | | | | | | 1.549 | | | | 2.405 | 2.646 | | |
| | 4" | | | | | | | | | 1.742 | | 2.262 | 2.646 | | |
| | 5" | | | | | | | | | | | | | 3.439 | |
| Te{ tik so navoj @ Quik-T ST 08T  | 1/2" | | | 548 | 602 | 697 | | 945 | | | | | | | |
| | 3/4" | | | 548 | 602 | 697 | | 945 | | | | | | | |
| | 1" | | | 548 | 773 | 697 | | 899 | | | | | | | |
| | 1 1/4" | | | 635 | 773 | 813 | 909 | 899 | | 1.219 | | 1.373 | 1.373 | | |
| | 1 1/2" | | | 635 | 773 | 813 | 909 | 899 | 1.224 | 1.219 | 1.383 | 1.373 | 1.373 | | |
| | 2" | | | | | 940 | | 940 | 1.224 | 1.219 | | 1.431 | 1.431 | 2.280 | |
| | 2 1/2" | | | | | | | 960 | | | | 1.431 | 1.431 | 2.280 | |
| | 3" | | | | | | | 1.142 | | | | 1.663 | 1.663 | 2.280 | |
| Разклонител- Т с канал Quik-T ST 08G  | 1 1/4" | | | 691 | 842 | 840 | | 978 | | 1.219 | | 1.373 | 1.373 | | |
| | 1 1/2" | | | 691 | 842 | 840 | | 978 | | 1.219 | | 1.373 | 1.373 | | |
| | 2" | | | | | 872 | | 1.023 | | 1.259 | | 1.373 | 1.373 | | |
| | 2 1/2" | | | | | | | 1.023 | | 1.277 | | 1.373 | 1.373 | 2.172 | |
| | 3" | | | | | | | 1.121 | | | | 1.663 | 1.663 | 2.217 | |
| | 4" | | | | | | | | | | | 2.223 | 2.223 | 2.373 | |
| | Krst ST 88T  | 1/2" | | | 894 | 983 | 1.046 | | 1.467 | | | | | | |
| | | 3/4" | | | 894 | 983 | 1.046 | | 1.467 | | | | | | |
| 1" | | | | 894 | 1.262 | 1.046 | | 1.467 | | | | | | | |
| 1 1/4" | | | | 1.036 | 1.262 | 1.260 | 1.365 | 1.467 | | 1.828 | | 2.059 | 2.059 | | |
| 1 1/2" | | | | 1.036 | 1.262 | 1.260 | 1.365 | 1.467 | 1.839 | 1.828 | 2.075 | 2.059 | 2.059 | | |
| 2" | | | | | | 1.457 | | 1.534 | 1.839 | 1.853 | | 2.146 | 2.146 | 3.420 | |
| 2 1/2" | | | | | | | | 1.534 | | | | 2.146 | 2.146 | 3.420 | |
| 3" | | | | | | | | 1.713 | | | | 2.495 | 2.495 | 3.420 | |
| Разклонител Quiklet ST 99  | 1/2" | | 227 | 227 | 281 | 393 | | | | | | | | | |
| | 3/4" | | 227 | 227 | 281 | 393 | | | | | | | | | |
| | 1" | | 273 | 273 | 318 | 444 | | | | | | | | | |
| Reducir ST 15  | 1 1/4" | | | 460 | 444 | 457 | | | | | | | | | |
| | 1 1/2" | | | | 460 | 449 | 466 | | | | | | | | |
| | 2" | | | | | 510 | 557 | 779 | 744 | | | 1.510 | 1.510 | | |
| | 2 1/2" | | | | | | 768 | 880 | 907 | | 1.042 | 1.510 | 1.510 | | |
| | 3" | | | | | | | 912 | 932 | | 1.042 | 1.510 | 1.510 | 1.929 | |
| | 4" | | | | | | | | | | 1.175 | 1.510 | 1.510 | 3.353 | |
| | 5" | | | | | | | | | | | 1.835 | 1.835 | 3.414 | |
| T - reducir ST 55  | 1" | | | | | 2.043 | | 1.813 | | | | | | | |
| | 1 1/2" | | | | | | | 1.926 | | | | | | | |
| | 2" | | | | | 2.072 | 1.825 | 2.125 | 2.570 | | | | 6.092 | | |
| | 2 1/2" | | | | | 1.901 | | 2.466 | | 3.606 | | | 6.092 | | |
| | 3" | | | | | | | 2.466 | | 3.667 | | | 5.847 | | |
| | 4" | | | | | | | | | | | | 5.847 | 5.381 | |
| | 5" | | | | | | | | | | | | | 6.118 | |
| Грес QUIKCOUP (0,91 kg) | 732 | | | | | | | | | | | | | | |