

CENOVNI K 3A

ИНДУСТРИСКИ ИНСТАЛАЦИИ

BEZRABNA CEVKA OD ^ELIK



STANDARD: DIN 2448 / 1629
 MATERI JAL: ST.37 - ^.1212 / ST.35.8 - ^.1214
 POTEKLO: ^E[KA, ROMANI JA
 DOL@I NA: 5 mtr - 7 mtr
 LEGENDA:
S - DEBELI NA NA YI DOT
D - NADVORE[EN DI JAMETAR

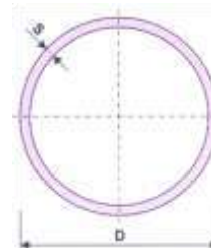

D, mm	S, mm	kg / mtr	cena / mtr bez DDV	cena / kgr bez DDV
10,2	1,6	0.339		
13,5	2,0	0.567		
	2,6	0.699		
17,2	2,3	0.845		
	2,9	1.02		
21,3	2,3	1.08		
	2,6	1.20	107	89
	2,9	1.32		
26,9	2,3	1.40	125	89
	2,6	1.56	139	89
	2,9	1.72	153	89
33,7	2,6	1.99	177	89
	2,9	2.20		
	3,2	2.41		
38,0	2,6	2.27		
	2,9	2.51		
	3,6	3.05		
42,4	2,6	2.55	227	89
	2,9	2.82		
	3,2	3.09		
48,3	2,6	2.93	261	89
	2,9	3.25		
	3,2	3.56		
51,0	2,6	3.10		
	2,9	3.44		
	4,0	4.64		
57,0	2,9	3.87	231	89
	3,2	4.25		
	3,6	4.74		
60,3	2,9	4.11	366	89
	3,2	4.51		
	3,6	5.03		
63,5	2,9	4.33		
	3,6	5.32		
	4,0	5.87		
70,0	2,9	4.80		
	3,2	5.27		
	3,6	5.90		
76,1	2,9	5.24	467	89
	3,2	5.75		
	3,6	6.44	574	89
	4,5		708	89

D, mm	S, mm	kg / mtr	cena / mtr bez DDV	cena / kgr bez DDV
88,9	3,2	6.76	603	89
	3,6	7.57		
	4,0	8.38		
101,6	3,6	8.70		
	4,0	9.63		
	5,0	11.90		
108,0	3,6	9.27	827	89
	4,0	10.30	917	89
	4,5	11.50		
114,3	3,6	9.80	874	89
	4,0	10.90	970	
	4,5	12.20		
133,0	4,0	12.70	1131	89
	5,0	15.80	1409	89
	6,3	19.70		
	8,0		2198	89
159,0	4,5	17.10	1552	89
	5,0		1692	89
	5,6	21.20		
	6,3	23.70		
168,3	4,5	18.2	1620	89
219,1	6,3	33.1	2947	89
	7,1	37.10		
	10,0	51.60		
273,0	7,1	46.60		
	8,0	52.30		
323,9	7,1	55.50		
	8,0	62.30		
355,6	8,0	68.60		
406,4	11,0	107.00		

ZABELE[KA:
 PO NARA^KA NUDI ME I
 VI SOKOPRECI ZNI CEVKI

*цените се во денари

*го задржуваме правото на измени без обврска кон клиентите

STANDARD: ANSI B.36.10

MATERI JAL: API 5L, A 106

POTEKLO: ^E[KA, ROMANI JA

DOL@I NA: 5 mtr - 7 mtr

LEGENDA:

S - DEBELI NA NA YI DOT

D - NADVORE[EN DI JAMETAR

ND - NOMI NALEN DI JAMETAR

D, mm	DEBELI NA SCH STD				DEBELI NA SCH XS			
	ND, inch	S, mm	kg / mtr	cena / mtr	ND, inch	S, mm	kg / mtr	cena / mtr
21.3	1/2"	2.8	1.27	304	1/2"	3.7	1.62	387
26.7	3/4"	2.9	1.68	374	3/4"	3.9	2.19	487
33.4	1"	3.4	2.50	524	1"	4.6	3.23	681
42.2	5/4"	3.6	3.38	672	5/4"	4.9	4.47	888
48.3	6/4"	3.7	4.05	756	6/4"	5.1	5.41	1,010
60.3	2"	3.9	5.44	1,017	2"	5.5	7.48	1,395
73.0	2 1/2"	5.2	8.62	1,584	2 1/2"	7.0	11.40	2,077
88.9	3"	5.5	11.30	2,056	3"	7.6	15.30	2,782
114.3	4"	6.0	16.10	2,868	4"	8.6	22.30	3,992
141.3	5"	6.6	21.80	3,957	5"	9.5	31.00	5,632
168.3	6"	7.1	28.30	5,141	6"	11.0	42.60	7,737
219.1	8"	8.2	42.60	8,742	8"	12.7	64.60	13,285
273.0	10"	9.3	60.30	12,392	10"	12.7	81.60	16,758
323.8	12"	9.5	73.90	15,155	12"	12.7	97.50	19,985
355.6	14"	9.5	81.30	16,670	14"	12.7	107.00	22,023

D, mm	DEBELI NA SCH 20				DEBELI NA SCH 30			
	ND, inch	S, mm	kg / mtr	cena / mtr	ND, inch	S, mm	kg / mtr	cena / mtr
219.1	8"	6.4	33.30	6,828	8"	7.0	36.80	7,550
273.0	10"	6.4	41.80	8,572	10"	7.8	51.00	10,470
323.8	12"	6.4	49.70	10,193	12"	8.4	65.20	13,370

D, mm	DEBELI NA SCH 40			
	ND, inch	S, mm	kg / mtr	cena / mtr
323.8	12"	10.3	79.70	16,390
355.6	14"	11.1	94.50	19,400

БЕЗРАБНИ ЦРНИ КОЛЕНА

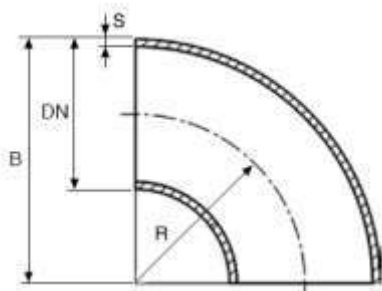
RACCORDERIE METALLICHE

Арт. 704

Безшавни челични колена 90°

Стандарт: EN 10253-1 (DIN 2605)

Материјал: P235TR1 - S235 (R.St.37.0)

DN	S				Без ДДВ	Со ДДВ
мм	мм				ден/пар	ден/пар
17,2	2				127	150
21,3	2				64	76
26,9	2,3				64	76
33,7	2,6				60	71
42,4	2,6				71	84
48,3	2,6				90	106
57	2,9				159	188
60,3	2,9				137	162
70	2,9				195	230
76,1	2,9				196	231
88,9	3,2				311	367
101,6	3,6				505	596
108	3,6				518	611
114,3	3,6				534	630
133	4				935	1103
139,7	4				1022	1206
159	4,5				1355	1599
168,3	4,5				1474	1739
193,7	5,6				2719	3208
219,1	6,3				3904	4607
244,5	6,3				8247	9731
273	6,3				6995	8254
323,9	7,1				11311	13347

БЕЗРАБНИ ЦРНИ КОНЦЕНТРИЧНИ РЕДУЦИРИ

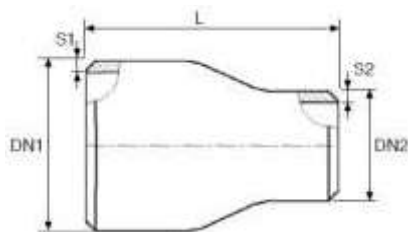

Арт. 276
 Безрабни челични концентрични редуцири
 Стандард: DIN 2616 серија 3

DN1	DN2	S1	S2	L	Без ДДВ	Со ДДВ
мм	мм	мм	мм	мм	ден/пар	ден/пар
33,7	26,9	2,6	2,3	50	158	186
42,4	26,9	2,6	2,3	50	171	202
42,4	33,7	2,6	2,6	50	156	184
48,3	26,9	2,6	2,3	64	231	273
48,3	33,7	2,6	2,6	64	189	223
48,3	42,4	2,6	2,6	64	162	191
60,3	33,7	2,9	2,6	76	239	282
60,3	42,4	2,9	2,6	76	207	244
60,3	48,3	2,9	2,6	76	182	215
76,1	42,4	2,9	2,6	90	281	332
76,1	48,3	2,9	2,6	90	248	293
76,1	60,3	2,9	2,9	90	226	267
88,9	42,4	3,2	2,6	90	587	693
88,9	48,3	3,2	2,6	90	414	489
88,9	60,3	3,2	2,9	90	326	385
88,9	76,1	3,2	2,9	90	269	317
101,6	60,3	3,6	2,9	100	735	867
101,6	76,1	3,6	2,9	100	499	589
101,6	88,9	3,6	3,2	100	452	533
108	60,3	3,6	2,9	100	713	841
108	76,1	3,6	2,9	100	542	640
108	88,9	3,6	3,2	100	453	535
114,3	60,3	3,6	2,9	100	731	863
114,3	76,1	3,6	2,9	100	567	669
114,3	88,9	3,6	3,2	100	494	583
114,3	101,6	3,6	3,6	100	473	558
133	76,1	4	2,9	127	1310	1546
133	88,9	4	3,2	127	960	1133
133	101,6	4	3,6	127	1203	1420
133	108	4	3,6	127	855	1009

DN1	DN2	S1	S2	L	Без ДДВ	Со ДДВ
мм	мм	мм	мм	мм	ден/пар	ден/пар
133	114,3	4	3,6	127	859	1014
139,7	76,1	4	2,9	127	1344	1586
139,7	88,9	4	3,2	127	1142	1348
139,7	101,6	4	3,6	127	1111	1311
139,7	108	4	3,6	127	961	1134
139,7	114,3	4	3,6	127	861	1016
139,7	133	4	4	127	816	963
159	88,9	4,5	3,2	140	1919	2264
159	101,6	4,5	3,6	140	1579	1863
159	108	4,5	3,6	140	1359	1604
159	114,3	4,5	3,6	140	1225	1446
159	133	4,5	4	140	1032	1218
159	139,7	4,5	4	140	1033	1219
168,3	88,9	4,5	3,2	140	1940	2289
168,3	101,6	4,5	3,6	140	1728	2039
168,3	108	4,5	3,6	140	1589	1875
168,3	114,3	4,5	3,6	140	1271	1500
168,3	133	4,5	4	140	1093	1290
168,3	139,7	4,5	4	140	1099	1297
168,3	159	4,5	4,5	140	1108	1307
219,1	114,3	6,3	3,6	152	3078	3632
219,1	133	6,3	4	152	2378	2806
219,1	139,7	6,3	4	152	2024	2388
219,1	159	6,3	4,5	152	1951	2302
219,1	168,3	6,3	4,5	153	1970	2325
273	159	6,3	4	178	4723	5573
273	168,3	6,3	4,5	178	3809	4495
273	219,1	6,3	6,3	178	3240	3823
323,9	219,1	7,1	6,3	178	6813	8039
323,9	273	7,1	6,3	178	6114	7215

*цените се во денари

*го задржуваме правото на измени без обврска кон клиентите

15.01.2019

FLITING ZA ZAVARUVAWE PO ANSI B.16.9 STD
MATERIALI: ASTM A234 SERTIFIKAT: DIN 50049/3.1.B

ND, inch	KONCEN. REDUCIR		EKSCENT. REDUCIR		TE[TIK REDUCIR		ND, inch	KONCEN. REDUCIR		EKSCENT. REDUCIR		TE[TIK REDUCIR	
3/4 X 1/2	60	71					4 X 11/2	465	549				
1 X 1/2	51	60					4 X 2	503	594				
1 X 3/4	47	55					4 X 2 1/2	443	523				
1 1/4 X 1/2	80	94					4 X 3	394	465				
1 1/4 X 3/4	89	105					4 X 3 1/2						
1 1/4 X 1	68	80					5 X 2	833	983				
1 1/2 X 1/2	138	163					5 X 2 1/2	1257	1483				
1 1/2 X 3/4	108	127					5 X 3	743	877				
1 1/2 X 1	84	99					5 X 3 1/2						
1 1/2 X 1 1/4	143	169					5 X 4	679	801				
2 X 1/2	218	257					6 X 2	1301	1535				
2 X 3/4	135	159					6 X 2 1/2	1103	1302				
2 X 1	125	148					6 X 3	1553	1833				
2 X 1 1/4	123	145					6 X 3 1/2						
2 X 1 1/2	288	340					6 X 4						
2 1/2 X 1	428	505					6 X 5	895	1056				
2 1/2 X 1 1/4	246	290					8 X 3	1721	2031				
2 1/2 X 1 1/2	355	419					8 X 4	1609	1899				
2 1/2 X 2	199	235					8 X 5	1520	1794				
3 X 1	337	398					8 X 6	1951	2302				
3 X 1 1/4	324	382					10 X 4	2986	3523				
3 X 1 1/2	302	356					10 X 5	2936	3464				
3 X 2	273	322					10 X 6	2790	3292				
3 X 2 1/2	392	463					10 X 8	2545	3003				
3 1/2 X 1 1/2							12 X 6	4177	4929				
3 1/2 X 2							12 X 8	3970	4685				
3 1/2 X 2 1/2							12 X 10	3504	4135				
3 1/2 X 3													

PROIZVODI TEL: RACORDERIE METALLICHE SPA, ITALIJA
 UVOZNI K: METALTERM DOO, SKOPJE, MAKEDONIJA

*цените се во денари

*го задржуваме правото на измени без обврска кон клиентите

14.09.2012

BEZRABEN FI TI NG ZA ZAVARUVAWE

FI TI NG ZA ZAVARUVAWE PO **ANSI B.16.9 STD**
 MATERI JAL: **ASTM A234** SERTI FI KAT: **DIN 50049/3.1.B**
 CENA денари без и SO DDV, PAR^E

ND, inch	NADVORE[EN DI JAMETAR	DEBELI NA NA YI DOT	KOLENO		TE[TI K		KAPA	
			без DDV	со ДДВ	без DDV	со ДДВ	без DDV	со ДДВ
1/2"	21,34	2,77	45	53	80	94		
3/4"	26,67	2,87	51	60	107	126		
1"	33,40	3,38	79	94			41	48
1 1/4"	42,16	3,56	90	107	168	198	56	66
1 1/2"	48,26	3,68	132	156	236	278	62	73
2"	60,33	3,91	176	208			78	92
2 1/2"	73,03	5,16	328	387	556	656	142	168
3"	88,90	5,49	490	578	1067	1259	191	225
3 1/2"	101,60	5,74	607	716				
4"	114,30	6,02	851	1004	1248	1473	297	350
5"	141,30	6,55	1363	1608	2010	2372	561	662
6"	168,28	7,11	2132	2516	2769	3267	752	887
8"	219,08	8,18	4007	4728	4709	5557	1449	1710
10"	273,05	9,27	7197	8493	7182	8475	1760	2077
12"	323,85	9,53	10530	12425	9759	11516	2072	2445



PROI ZVODI TEL: **RACORDERIE METALLICHE SPA**, I TALI JA
 UVOZNI K: **METALTERM DOO**, SKOPJE, MAKEDONI JA

*цените се во денари

*го задржуваме правото на измени без обврска кон клиентите

01.01.2015

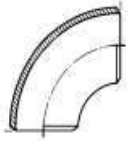
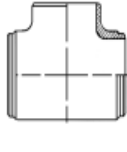
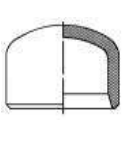
FITING ZA ZAVARUVAWE PO ANSI B.16.9 XS
MATERIAL: ASTM A234 SERTIFIKAT: DIN 50049/3.1.B
PO BARAVE

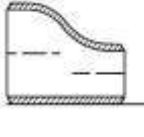
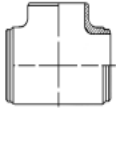
ND, inch	DEBELI NA NA YI DOT				ND, inch			
1/2"	3,73				3/4 X 1/2			
3/4"	3,91				1 X 1/2			
1"	4,55				1X3/4			
1 1/4"	4,85				1 1/4 X 1/2			
1 1/2"	5,08				1 1/4 X 3/4			
2"	5,54				1 1/4 X 1			
2 1/2"	7,01				1 1/2 X 1			
3"	7,62				1 1/2 X 1 1/4			
3 1/2"	8,08				2 X 1			
4"	8,56				2 X 1 1/4			
5"	9,53				2 X 1 1/2			
6"	10,97				2 1/2 X 1 1/2			
8"	12,70				2 1/2 X 2			
10"	12,70				3 X 1 1/2			
12"	12,70				3 X 2			
14"	12,70				3 X 2 1/2			
16"	12,70				4 X 2			
18"	12,70				4 X 2 1/2			
					4 X 3			
					5 X 2			
					5 X 2 1/2			
					5 X 3			
					5 X 4			
					6 X 2 1/2			
					6 X 3			
					6 X 4			
					6 X 5			
					8 X 4			
					8 X 5			
					8 X 6			
					10 X 4			
					10 X 5			
					10 X 6			
					10 X 8			
					12 X 6			
					12 X 8			
					12 X 10			

PROIZVODI TEL: RACORDERIE METALLICHE SPA, ITALIJA
 UVOZNI K: METALTERM DOO, SKOPJE, MAKEDONIJA

*цените се во денари

*го задржуваме правото на измени без обврска кон клиентите

CRNA RABNA CEVKA **DIN 2440**

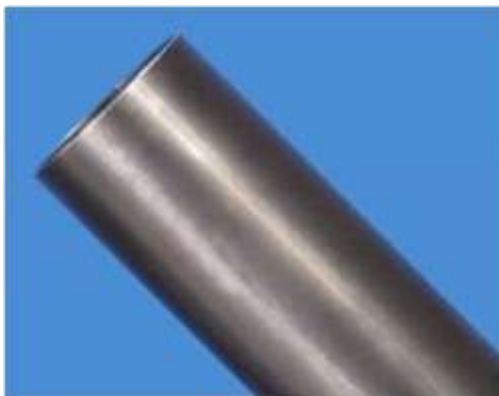

CRNA RABNA CEVKA DIN 2440			
DI MENZI JA	EDI N. MERKA	CENA БЕЗ DDV	CENA SO DDV
3/8"	MTR.	51	60
1/2"	MTR.	57	67
3/4"	MTR.	75	89
1"	MTR.	114	134
1 1/4"	MTR.	147	173
1 1/2"	MTR.	206	243
2"	MTR.	208	246
2 1/2"	MTR.	308	363
3"	MTR.	427	504
4"	MTR.		

FITING OD ^ELIK

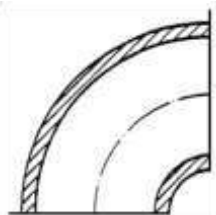
CRNO KOLENO: R = 1.5 D
STANDARD: DIN 2605
MATERIALI: ST.37 - ^.1212
POTEKLO: ITALIJA
LEGENDA:
S - DEBELINA NA YI DOT
D - NADVORE[EN DI JAMETAR
ND - NOMI NALENDI JAMETAR

ND, inch	D, mm	S, mm	kg / парче	Pakuvawe	Cena/par. bez ddv	Cena / par.so ddv
1/2"	21.3	2.0	0.04	100	94	103
3/4"	26.9	2.3	0.07	100	51	62
1"	33.7	2.6	0.12	80	59	70
5/4"	38.0	2.6	0.16	80	94	111
5/4"	42.4	2.6	0.19	50	71	84
6/4"	44.5	2.6	0.22	50		
6/4"	48.3	2.6	0.27	50	79	93
6/4"	51.0	2.6	0.33	50		
2"	57.0	2.9	0.44	25	150	177
2"	60.3	2.9	0.49	25	128	151
2"	63.5	2.9	0.58	5		
2 1/2"	70.0	2.9	0.70	5	207	244
2 1/2"	76.1	2.9	0.79	5	186	219
3"	88.9	3.2	1.22	5	267	315
3 1/2"	101.6	3.6	1.83	4	453	535
4"	108.0	3.6	2.08	4	486	573
4"	114.3	3.6	2.37	4	515	608
5"	133.0	4.0	3.64	3	712	840
5"	139.7	4.0	4.04	3	873	1030
6"	159.0	4.5	5.90	3	1093	1290
6"	168.3	4.5	6.50	1	1508	1780
8"	219.1	6.3	14.90	1	2797	3300
10"	273.0	6.3	24.90	1	7034	8300
12"	323.9	7.1	40.00	1	10593	12500

CRN MUF
STANDARD: DIN 2605
MATERIALI:
ST.37 - ^.1212
POTEKLO: ITALIJA

ND, inch	S, mm	Pakuvawe	Cena/par. bez ddv	Cena / par.so ddv	ЦРН МУФ НАВОЈ/ ЗАВАРУВАЊЕ	ЦРН МУФ НАВОЈ/ ЗАВАРУВАЊЕ
					ЦЕНА БЕЗ ДДВ	ЦЕНА СО ДДВ
3/8"	2.35	150	21	25		
1/2"	2.65	150	33	39	41	48
3/4"	2.65	150	37	44	43	51
1"	3.25	10	74	87	46	54
5/4"	3.25	50	77	91	50	59
6/4"	3.25	40	101	119	77	91
2"	3.65	25	136	160	127	150
2 1/2"	3.65	1	216	255	220	260
3"	4.05	1	278	328	183	330
4"	4.50	1	565	667		

*цените се во денари

*го задржуваме правото на измени без обврска кон клиентите

30/05/2018

VENTI LI SO PRI RABNI CI PO DIN

DN	[I BER PLOSNAT F4 PN 10/16		[I BER PLOSNAT F4 PN 10		[I BER PLOSNAT F5 PN 16		FI LTER PN 16	
	Цени без ддв	Цени со ддв	Цени без ддв	Цени со ддв	Цени без ддв	Цени со ддв	Цени без ддв	Цени со ддв
15							857	1011
20							1074	1267
25							1380	1628
32							1857	2191
40	3763	4440			4407	5200	2103	2482
50	4147	4893			5181	6114	2864	3380
65	5071	5984			6013	7095	3973	4688
80	5831	6881			6834	8064	4713	5561
100	7500	8850			8620	10172	6786	8007
125	11850	13983			12563	14824	10853	12807
150	13978	16494			15000	17700	14215	16774
200			26750	31565	29961	35354	23575	27819
250			43835	51725	48286	56977	45033	53139
300			64223	75783	70646	83362	62568	73830
								

DN	RAMEN ZAPOREN PN 16		TOP^EST PN 16		НЕПОВРАТЕН СО КЛАПНА PN 16 SWING		НЕПОВРАТЕН СО ТЕГ PN 16	
	Цени без ддв	Цени со ддв	Цени без ддв	Цени со ддв	Цени без ддв	Цени со ддв	Цени без ддв	Цени со ддв
15	1582	1867	2516	2969			1550	1829
20	1819	2146	2803	3308			1783	2104
25	2308	2723	3226	3807			2262	2669
32	3238	3821	3440	4059			3036	3582
40	4111	4851	3793	4476	3838	4529	3864	4560
50	5519	6512	4498	5308	4471	5276	5188	6122
65	6610	7800	6231	7353	6097	7194	6307	7442
80	9431	11129	8226	9707	6935	8183	8959	10572
100	12205	14402	11084	13079	8756	10332	11845	13977
125	19530	23045	19002	22423	13827	16316	18782	22163
150	25784	30425	29212	34470	19026	22451	24787	29249
200	46153	54461	51482	60749	33148	39115	43937	51846
250	90999	107379			52604	62073		
300	145059	171170						
								

Uvozni k: Metal term DOO

 Proizvodi tel : *UMB - Romania, Duyar Vana, Polix*

*цените се во денари

*го задржуваме правото на измени без обврска кон клиентите

24.07.2017

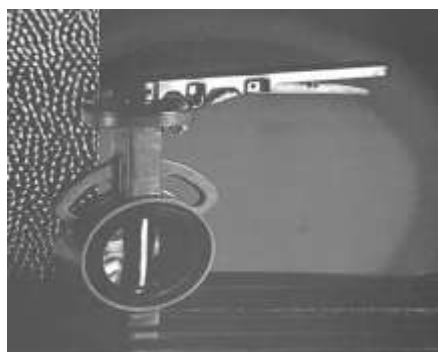
VENTIL TIPI "LEPTIR"

DI - MENZI JA	CENA VO DENARI									
	DI SK OD SI V LI V					DI SK INOX AISI 316				
	DUYAR		belven		sferaco ROBINETTERIE & RACCORDS	belven		sferaco ROBINETTERIE & RACCORDS		
	Цени без ДДВ	Цени со ДДВ	Цени без ДДВ	Цени со ДДВ	Цени без ДДВ	Цени со ДДВ	Цени без ДДВ	Цени со ДДВ	Цени без ДДВ	Цени со ДДВ
2"	1821	2149	3370	3977	1491	1759	3846	4538	1914	2259
2 1/2"	1994	2353	3370	3977	1690	1994	4361	5146	2245	2649
3"	2199	2595	3917	4622	1884	2223	4678	5520	2574	3037
4"	3485	4112	4520	5334	2397	2828	5749	6784	3748	4423
5"	4024	4748	5313	6269	3174	3745	6859	8094	4933	5821
6"	4414	5209	6066	7158	3772	4451	7374	8701	6418	7573
8"	4581	8946	9475	11181	5942	7012	11854	13988	10159	11988
10"	14233	16795	14769	17427	10000	11800	21211	25029	16358	19302
12"	17125	20208	19169	22619	12793	15096	31261	36888	24456	28858

Uvozni k: Metal term DOO

 Proizvodi tel : *Belven, Sferaco, Duyar Vana*
ЧЕЛИЧЕН ТОПЧЕСТ ВЕНТИЛ НА ЗАВАРУВАЊЕ ЗА ВОДА PN 25/40 T -30+200*°C

ДИМЕНЗИЈА	ЦЕНА БЕЗ ДДВ	ЦЕНА СО ДДВ
15	1129	1332
20	1292	1525
25	1659	1958
32	2030	2395
40	2896	3417
50	3396	4007
65	4993	5892
80	6656	7854
100	9506	11217
125	15714	18543
150	21859	25794
200	45954	54226



*цените се во денари

*го задржуваме правото на измени без обврска кон клиентите

20.05.2019

КОНДЕНЗНИ ЛОНЧИЊА

МАТЕРИЈАЛ

ТЕЛО	ГУСЕН
КАПАК/ТАПА	ГУСЕН
НАСЕД	SS 410
ДИСК	SS 304
ЗАПТИВКА	PTFE
ФИЛТЕР	SS 304

Термодинамички тип

Притисок на испитување: Тело 32 bar (Хидростатично)

Работен притисок: 0,3 bar – 16 bar

Температура: 220°C

КАПАЦИТЕТ (кг/час)

P BAR	0,3	0,6	1	2	3	4	5	6	8	10	12	14	16
15 – 25	183	220	253	330	345	385	420	450	510	570	630	680	740
32	350	410	490	620	730	820	900	960	1080	1200	1320	1440	1560
40	440	520	610	780	900	1000	1090	1180	1350	1500	1650	1790	1930
50	460	560	670	850	1000	1110	1220	1320	1500	1680	1860	2030	2200

ST-T3F Фланши

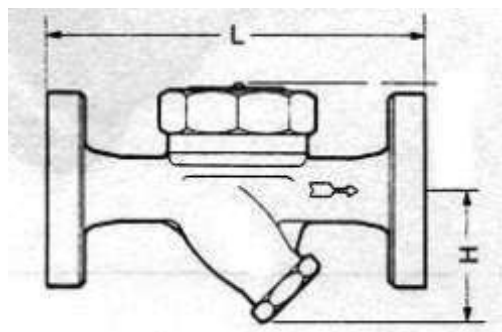

ДУ	цол	1/2	3/4	1	1 1/4	1 1/2	2
	мм	15	20	25	32	40	50
L (мм)		142	160	182	244	244	268
H (мм)		67	73	92	107	107	125
ЦЕНА БЕЗ ДДВ		3417	4851	5752	6923	9821	17212
ЦЕНА СО ДДВ		4032	5724	6787	8169	11589	20310

Димензии на фланшите – по DIN

ST-T3A Навој

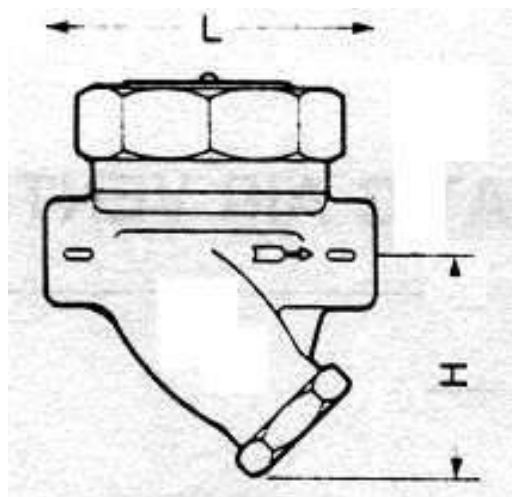

ДУ	цол	1/2	3/4	1	1 1/4	1 1/2	2
	мм	15	20	25	32	40	50
L (мм)		67	105	112	173	187	203
H (мм)		54	56	61	87	92	101
ЦЕНА БЕЗ ДДВ		2302	2391	2505	5432	5567	6898
ЦЕНА СО ДДВ		2716	2821	2956	6410	6569	8140

Димензии на навојот – по BS21, ANSI B2.1 или DIN 259

ПРОИЗВОДИТЕЛ: 317 LTD., ТАЈВАН
 УВОЗНИК: МЕТАЛТЕРМ ДОО, СКОПЈЕ

*цените се во денари

*го задржуваме правото на измени без обврска кон клиентите

28.05.2019

НЕПОВРАТНИ КЛАПНИ

Двоен диск Тело: гус Диск: гус Заптивање: EPDM РУ 16, Т 110°C  05	Еднодисков Тело: инокс 304/316 Диск: инокс 304/316 Заптивање: метал/метал РУ 40, Т 200°C 	Еднодисков Заптивање: метал/метал РУ 16, Т 120°C Тело: месинг Диск: инокс 304 	Еднодисков Заптивање: метал/метал РУ 16, Т 120°C Тело: гус Диск: гус 	Тип Мигалка Тело: железо Диск: железо Заптивање: EPDM/NBR РУ 16, Т 110°C 	Тип Мигалка Тело: 316/316L Диск: 316/316L Заптивање: FKM РУ 16, Т 180°C 
--	--	---	--	--	---

ДИМЕНЗИЈА ДН	ЦЕНА СО ДДВ	ЦЕНА СО ДДВ	ЦЕНА СО ДДВ	ЦЕНА СО ДДВ	ЦЕНА СО ДДВ	
15		1391	1043			
20		1769	1238			
25		2243	1334			
32		2982	1841			
40		3744	2101		1155	
50	1222	5413	3089		1251	
65	1497	8503	4112		1460	
80	1958	11934	5148		1770	
100	2461	14318	7210		2319	
125	3075	По барање димензии ДН125—ДН600		10671	3117	Димензии: ДН40 - ДН600
150	4096			13937	3815	
200	7000			20140	6125	
250	8927				9694	
300	14277				15552	
350	26452					
400	90657					
450	129959					
500	153328					

^ELI ^NI FLAN[I PO DIN



DI - MENZI JA	DIN 2633/PN 16 SO GRLO		DIN 2635/PN 40 SO GRLO		DIN 2527/PN10 SLEPA		DIN 2566/PN16 SO NAVOJ		DIN 2576/PN 10 RAMNA		DIN 2576/PN 16 RAMNA	
	без ДДВ	со ДДВ	без ДДВ	со ДДВ	без ДДВ	со ДДВ	без ДДВ	со ДДВ	без ДДВ	со ДДВ	без ДДВ	со ДДВ
1/2"	276	326	348	411	158	186	155	183	102	120	168	198
3/4"	325	383	372	439	266	314	386	456	113	133	180	212
1"	329	388	407	480	290	342	445	525	141	166	204	241
1 1/4"	484	571	556	656	395	466	470	555	186	219	312	368
1 1/2"	531	627	677	799	447	528	496	585	237	280	354	418
2"	677	799	809	955	472	557	611	721	305	360	426	503
2 1/2"	822	970	1,026	1,211	617	728	864	1,019	360	425	540	637
3"	930	1,097	1,208	1,425	758	895	979	1,155	465	549	642	758
4"	1,159	1,368	2,270	2,679	942	1,111	1,073	1,266	489	577	714	843
5"	1,570	1,853	2,803	3,307	1,401	1,653	1,201	1,417	723	853	960	1133
6"	1,933	2,281	2,971	3,506	1,739	2,052	2,077	2,451	778	918	1200	1416
8"	3,188	3,762	6,256	7,382	2,754	3,250			1222	1442	1897	2238
10"	5,826	6,875	10,119	11,941	4,348	5,131			1525	1800	2388	2818
12"			13,960	16,473	5,482	6,469			1819	2146	2606	3075

ELEMENTI ZA SPOJUVAWE NA PIRABNICI

ZAPTI VEN ELEMENT - DIHTUNG OD KLINGERIT

RABOTNA TEMPERATURA: DO 300°C

DEBELINA: 2 - 4 mm VO ZAVISNOST OD NO

DIMENZIJI SOGLASNO DIN 2690

OD NO 15 DO NO 300



DI MENZIJA	CENA/PAR^E BEZ DDV	CENA/PAR^E SO DDV
15	19	22
20	25	30
25	28	33
32	45	53
40	52	61
50	76	90
65	108	128
80	114	134
100	127	150
125	242	286
150	303	357
200		
250		
300		

MA[INSKI ZAVRTKI I NAVRTKI

KVALITET: 5.6 DO NP16, CRNI I ICIKANI

ZAVRTKI		
DI MENZIJA	CENA/PAR^E BEZ DDV	CENA/PAR^E SO DDV
M 12 / 50	13	15
M 16 / 60	31	36
M 16 / 70	32	38

NAVRTKI		
DI MENZIJA	CENA/PAR^E BEZ DDV	CENA/PAR^E SO DDV
M 12	6	7
M 16	10	12

 LEGENDA: **L** - AKTI VNA DOLINA NA ZAVRTKATA

M - NAVOJ

n - BROJ NA DUPKI

NO	NP 6			NP 10			NP 16			NP 25/40		
	L	M	n	L	M	n	L	M	n	L	M	n
15	40	10	4	45	12	4	45	12	4	50	12	4
20	45	10	4	50	12	4	50	12	4	50	12	4
25	45	10	4	50	12	4	50	12	4	50	12	4
32	45	12	4	50	16	4	50	16	4	55	16	4
40	45	12	4	50	16	4	50	16	4	55	16	4
50	45	12	4	55	16	4	55	16	4	60	16	4
65	45	12	4	55	16	4	55	16	4	65	16	8
80	60	16	4	60	16	4	60	16	8	70	16	8
100	60	16	8	60	16	8	60	16	8	70	20	8
125	60	16	8	65	16	8	65	16	8	80	24	8
150	60	16	8	65	20	8	65	20	8	90	24	8

*цените се во денари

*го задржуваме правото на измени без обврска кон клиентите

DI LATACI ONI KOMPENZATORI

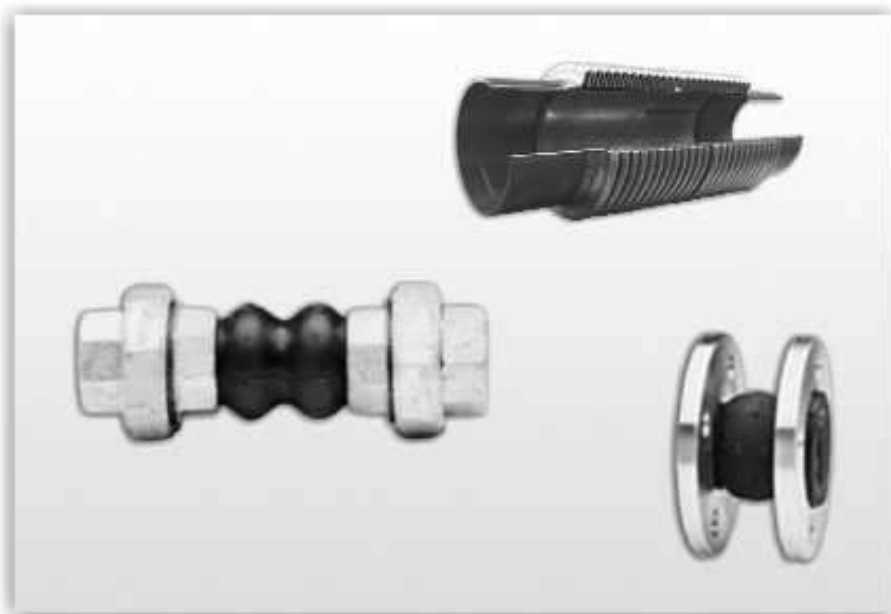

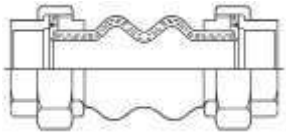
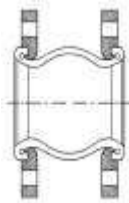
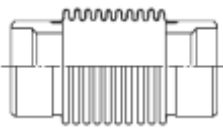
DI MENZI JA	GUMEN KOMPENZATOR SO HOLENDERI		GUMEN KOMPENZATOR SO PRIRABNICI				KOMPENZATOR SO ZAVARUVAWE	
	без ДДВ	со ДДВ	PN10		PN16		без ДДВ	со ДДВ
1/2"	874	1031						
3/4"	874	1031						
1"	1086	1281					2815	3322
1 1/4"	1236	1458	1497	1766			3272	3861
1 1/2"	1456	1718	1535	1811			3576	4220
2"	1716	2025	1834	2164			3823	4511
2 1/2"	2687	3171	2250	2655			5098	6016
3"	3658	4316	2592	3059			5573	6576
4"			3265	3853			7342	8664
5"			3985	4702			9796	11559
6"			5166	6096			11090	13086
8"			7674	9055	9335	11016	15369	18135
10"			11721	13831	12936	15265		
12"			15894	18755	17811	21017		
14"			21740	25653				
16"			25527	30122				
								

El elektro - magneten ventili **TORK**



Proizvodi tel : **Tork**, Turcija
 Uvozni k: Metal term

Namena:
 Voda, vazduh, i neretni gasovi (azot, argon i dr.)

Temperatura:
 -10...+80°C

Napon:
 12 V AC/DC...220 V AC

Tip		Prikl u-ok	Светло сечение	KV	Pri ti sok		Cena, Denari /par	
					mm	lt/min	min bar	max bar
T-GM 102	H3	3/8"	12	40	0,5	16	2105	2484
T-GM 102A	HO			40	0,5	16	2368	2795
T-GM 103	H3	1/2"	14	45	0,5	16	2105	2484
T-GM 103A	HO			45	0,5	16	2368	2795
T-GM 104	H3	3/4"	17	80	0,5	16	2544	3002
T-GM 104A	HO			80	0,5	16	2807	3312
T-GM 105	H3	1"	17	80	0,5	16	2544	3002
T-GM 105A	HO			80	0,5	16	2807	3312
T-GM 109	H3	1 1/4"	40	400	0,5	10	7019	8282
T-GM 109A	HO			400	0,5	10	7282	8592
T-GM 106	H3	1 1/2"	40	400	0,5	10	7019	8282
T-GM 106A	HO			400	0,5	10	7282	8592
T-GM 107	H3	2"	50	540	0,5	10	7896	9317
T-GM 107A	HO			540	0,5	10	8159	9627
T-GM 102 N	H3	3/8"	12	40	0,5	16	2456	2898
T-GM 103 N	H3	1/2"	14	45	0,5	16	2544	3002

bez indeks (T-GM 102) - H3 normal no zatvoren
 indeks "A" (T-GM 102A) - HO normal no otvoren
 indeks "N" (T-GM 102N) - za naf ta

Po nara-ka se i spora-uvaat: $t_{max} = 160^{\circ}C$, $P_{min} = 0 \text{ bar}$, $P_{max} = 40 \text{ bar}$, 3" и др.

*цените се во денари

*го задржуваме правото на измени без обврска кон клиентите

Spojki i Fitinzi Quikcoup









 Proizvodi tel : *Modgal, Израел* Uvozni k: Metal term DOO

Oznaka		Cena, denari /par~e, so DDV													
		1"	1 1/4"	1 1/2"	2"	2 1/2"	3"	108	4"	133	5"	159	165	6"	8"
	Fl eksi bi l na spojka Flexible coupling ST 75		275	290	299	354	436	875	709	992	1.009	1.180	1.192	1.192	1.785
	Spojka Rigid coupling ST 75RT		286	299	312	367	452		744		1.058		1.215	1.215	1.852
	Fl eksi bi l na spojka Quikhinge ST 007	254	254	251	263	291	316		538		927		1.008	1.008	
	Spojka Quikhinge ST 007RT		254	254	254	254	254	254	254	254	254	254	254	254	254
	Kol eno 90° Quikbend ST 06		316	307	307	503	604	1.135	1.085	2.138	1.815	2.656	2.578	2.661	4.683
	Kol eno 45° Quikbend ST 04		316	307	307	503	604	1.135	1.085	2.138	1.815	2.656	2.578	2.661	4.683
	Te{ tik Tee ST 05	440	488	494	494	741	958	1.722	1.520	3.333	2.942	4.361	3.679	3.610	6.956
	Fl an{ a Quikflange ST 90				1.566	1.997	1.716		2.104		3.560		3.875	3.875	4.629
	Kol eno 90° Kratok radi us Quikbend ST 66	140	316	305	305	438	556	1.295	777		1.878		2.398	2.295	4.185
	Te{ tik Kratok radi us Tee ST 65	247	488	494	494	727	951	1.281	1.242		2.939	3.432	3.673	3.273	6.169
	Kapa End-cap ST 02		202	202	202	316	316	450	343	1.026	858	1.159	975	827	1.693

*цените се во денари

*го задржуваме правото на измени без обврска кон клиентите

04.04.2011

Oznaka	1"	1 1/4"	1 1/2"	2"	2 1/2"	3"	108	4"	133	5"	159	165	6"	8"	
Reducir spojka ST 71 	1 1/2"			604											
	2"				839	961		1.539							
	2 1/2"					961		1.539							
	3"							1.549				2.405	2.646		
	4"									1.742		2.262	2.646		
	5"														
Te{ tik so navoj @ Quik-T ST 08T 	1/2"			548	602	697		945							
	3/4"			548	602	697		945							
	1"			548	773	697		899							
	1 1/4"			635	773	813	909	899		1.219		1.373	1.373		
	1 1/2"			635	773	813	909	899	1.224	1.219	1.383	1.373	1.373		
	2"							940	940	1.224	1.219		1.431	1.431	2.280
	2 1/2"								960				1.431	1.431	2.280
	3"								1.142				1.663	1.663	2.280
Разклонител- Т с канал Quik-T ST 08G 	1 1/4"			691	842	840		978		1.219		1.373	1.373		
	1 1/2"			691	842	840		978		1.219		1.373	1.373		
	2"							872		1.023	1.259	1.373	1.373		
	2 1/2"								1.023	1.277		1.373	1.373	2.172	
	3"								1.121			1.663	1.663	2.217	
	4"											2.223	2.223	2.373	
	Krst ST 88T 	1/2"			894	983	1.046		1.467						
		3/4"			894	983	1.046		1.467						
1"				894	1.262	1.046		1.467							
1 1/4"				1.036	1.262	1.260	1.365	1.467		1.828		2.059	2.059		
1 1/2"				1.036	1.262	1.260	1.365	1.467	1.839	1.828	2.075	2.059	2.059		
2"						1.457		1.534	1.839	1.853		2.146	2.146	3.420	
2 1/2"								1.534				2.146	2.146	3.420	
3"								1.713				2.495	2.495	3.420	
Разклонител Quiklet ST 99 	1/2"		227	227	281	393									
	3/4"		227	227	281	393									
	1"		273	273	318	444									
Reducir ST 15 	1 1/4"			460	444		457								
	1 1/2"				460	449	466								
	2"					510	557	779	744			1.510	1.510		
	2 1/2"						768	880	907		1.042	1.510	1.510		
	3"							912	932		1.042	1.510	1.510	1.929	
	4"										1.175	1.510	1.510	3.353	
	5"											1.835	1.835	3.414	
Т - reducir ST 55 	1"						2.043		1.813						
	1 1/2"								1.926						
	2"					2.072	1.825	2.125	2.570				6.092		
	2 1/2"						1.901		2.466		3.606		6.092		
	3"								2.466		3.667		5.847		
	4"												5.847	5.381	
	5"													6.118	
Грес QUIKCOUP (0,91 kg)	732														