

# HYDRO 3-4 V2

Wall-mounted hydronic fan coil

IE

Instructions and  
recommendations

\*1.047640ENG\*

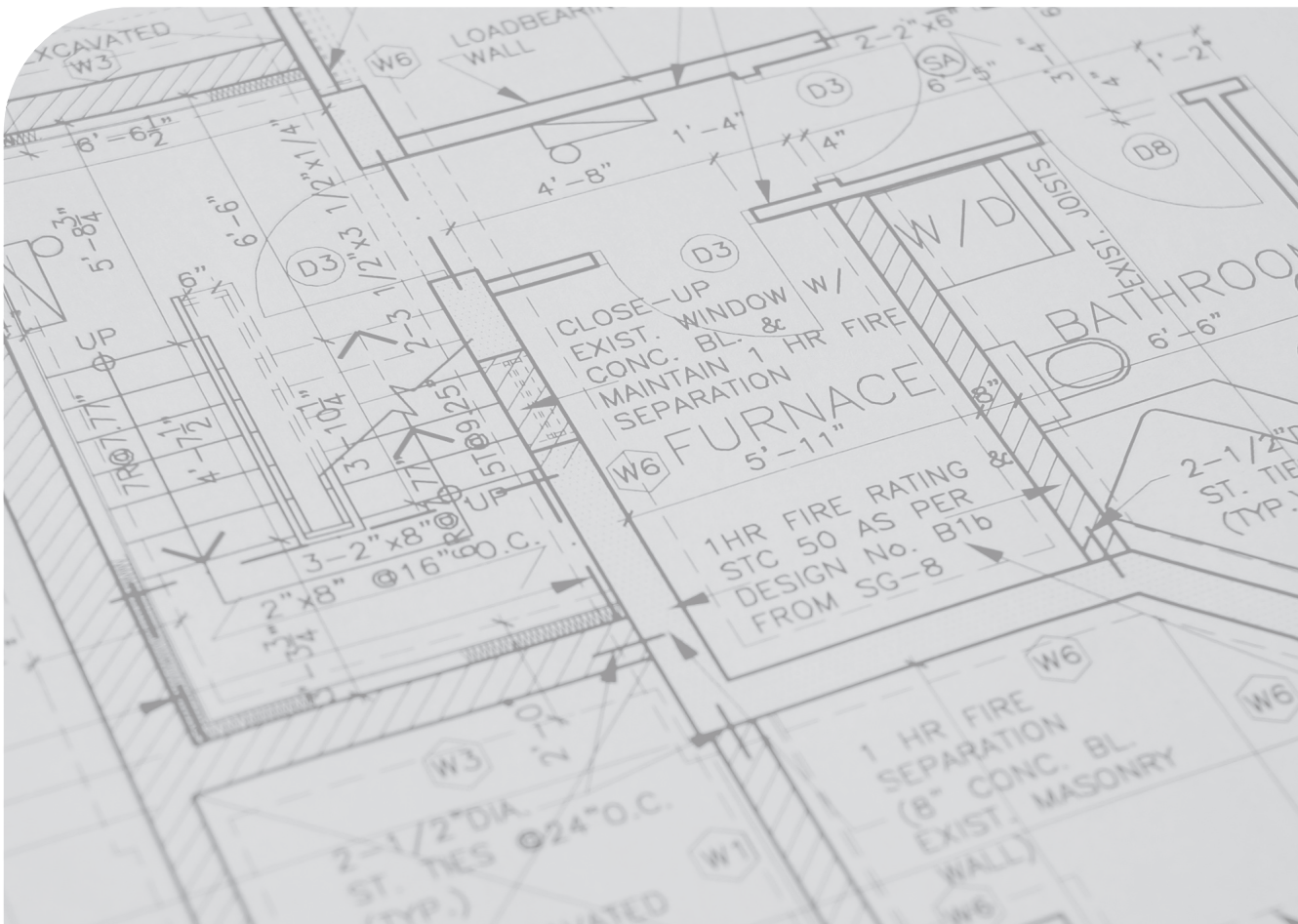



## **Dear Customer,**

*Congratulations for having chosen a top-quality Immergas product, able to assure well-being and safety for a long period of time. As an Immergas customer, you can always rely on a qualified Authorised Service Centre, trained and updated to guarantee constant efficiency for your wall-mounted hydronic water kit. Read the following pages carefully: you will be able to draw useful tips on the proper use of the device, compliance with which will confirm your satisfaction with the Immergas product.*

*For assistance and routine maintenance, contact Authorised Immergas Service Centres: they have original spare parts and are specifically trained directly by the manufacturer.*

## **General warnings**

*All Immergas products are protected with suitable transport packaging.*

*The material must be stored in a dry place protected from the weather.*

*The instruction booklet is an integral and essential part of the product and must be given to the new user in the case of transfer or succession of ownership.*

*It must be stored with care and consulted carefully, as all of the warnings provide important safety indications for installation, use and maintenance stages.*

*This instruction manual contains technical information for installing an Immergas wall-mounted hydronic water kit. As for the other issues related to kit installation (e.g. safety at the workplace, environmental protection, accident prevention), it is necessary to comply with the provisions specified in the regulations in force and with the principles of good practice.*

*In compliance with legislation in force, the systems must be designed by qualified professionals, within the dimensional limits established by the Law. Installation and maintenance must be performed in compliance with the regulations in force, according to the manufacturer's instructions and by professionally qualified staff, intended as staff with specific technical skills in the system sector, as envisioned by the Law.*

*Improper installation or assembly of the Immergas kit and/or components, accessories and devices can cause unexpected problems for people, animals and objects. Read the instructions provided with the product carefully to ensure proper installation.*

*Maintenance must be carried out by skilled technical staff. The Immergas Authorised After-sales Service represents a guarantee of qualifications and professionalism.*

*The hydronic kit must only be used for the purpose it was expressly intended for. Any other use will be considered improper and therefore potentially dangerous.*

*If errors occur during installation, operation and maintenance, due to non-compliance with technical laws in force, standards or instructions contained in this booklet (or however supplied by the manufacturer), the manufacturer is excluded from any contractual and extra-contractual liability for any damage and the appliance warranty is invalidated.*

*For further information on legislative and statutory provisions, consult the Immergas website: [www.immergas.com](http://www.immergas.com)*

The manufacture shall not be held liable for printing or transcription errors, reserving the right to make changes to the technical and commercial tables without prior notice.



## INDEX

<b>1 Important recommendations</b> .....	<b>5</b>
1.1 Warnings. ....	5
1.2 Installation. ....	7
1.3 Hydraulic connection. ....	8
1.4 Wiring. ....	9
<b>2 Introducing the product</b> .....	<b>11</b>
2.1 Important advice. ....	11
2.2 Technical features. ....	11
2.3 Accessories provided. ....	12
2.4 Components. ....	13
<b>3 Installation</b> .....	<b>14</b>
3.1 Installing the indoor unit. ....	14
3.2 Installing the water pipes. ....	18
3.3 Wiring diagram. ....	19
3.4 Commissioning. ....	21
<b>4 Parameter settings / Use</b> .....	<b>23</b>
4.1 Precautions when installing the remote controller. ....	23
4.1.1 Safety considerations. ....	23
4.1.2 Meaning of caution symbols. ....	23
4.1.3 Precautions in handling remote controller. ....	23
4.1.4 Installation site. ....	23
4.2 Dimensions of the remote controller and bracket. ....	24
4.3 Installation and fixing. ....	25
4.4 Replace the batteries. ....	26
4.5 Operating the remote controller. ....	26
4.5.1 Using Precautions. ....	26
4.5.2 Button names and functions. ....	27
4.5.3 Name and functions on display screen. ....	29
4.5.4 Operating modes. ....	30
<b>5 Recommendations - maintenance and repairs</b> .....	<b>33</b>
5.1 Advice for the user. ....	33
5.2 Household maintenance. ....	33
5.3 The following symptoms do not constitute a problem for the fan coil. ....	35
5.4 Troubleshooting support. ....	36
<b>6 Information requirements for fan coils.</b> .....	<b>38</b>
<b>7 Technical Data.</b> .....	<b>39</b>





# 1 IMPORTANT RECOMMENDATIONS

## 1.1 WARNINGS.

The device can be used by children at least 8 years old as well as by persons with reduced physical, sensory or mental capabilities, or lack of experience or required knowledge, provided that they are under surveillance, or after they have been instructed relating to the safe use and have understood the potential dangers.

Children must not play with the appliance.

Cleaning and maintenance destined to be performed by the user must not be carried out by unsupervised children.

This instruction manual should be read by the user and by skilled technical staff before using the kit.

Follow the instructions below to avoid damaging property and injuring the user or other persons. Improper use caused by failure to follow the instructions can result in damage or injury.

Check compliance with local, national and international laws and regulations.

Carefully read the "WARNINGS" section before installation.

The following precautions include basic safety notices to be observed and remembered.

Keep this manual handy for future consultation.

Failure to comply with the warnings can cause damage to the device and/or serious injury to the user.

**To avoid malfunctions, do not manually disconnect the supply voltage when the fan coil is running.**

**Ask a qualified technician to install the fan coil.**

**Contact the Service Centre for any malfunctions, repairs and periodic maintenance.**

Incomplete repairs or maintenance can cause water leaks, electric shocks and fires.

**To avoid electric shocks, fires or injuries, in the event of an anomaly, such as the smell of smoke, disconnect the supply voltage and call the Service Centre.**

**Make sure there is no water leaking in the indoor unit.**

Otherwise this could cause an electric shock or a fire.

**Do not press the remote control keys with hard or pointed objects.**

The remote control may break.

**Do not replace a fuse with another one with incorrect rated current or with other cables in case of malfunction.**

The use of cables to replace the fuse could damage the unit and cause a fire.

**Do not expose yourself to the air flow for prolonged periods.**

**Do not insert fingers, rods or other objects into the air inlet or outlet.**

High speed rotation of the fan can cause injury.

**Do not use flammable sprays, such as lacquers or paint, near to the unit.**

This could cause a fire.

**Do not touch the air outlet or the horizontal blades of the evaporator unit when the swinging fin is working.**

Fingers could get trapped or the unit could break.

**Do not place objects in front of the air inlet or outlet.**

Objects in contact with the fan at high speed can be dangerous.

**Do not inspect or work on the unit.**

Ask qualified staff to work on the unit.

**Do not dispose of this product as unsorted household waste. This device requires separate collection for special treatments.**

**Before cleaning the device, turn it off or unplug the power cable.**

Otherwise this could cause an injury or an electric shock.

**To avoid fires or electric shocks, make sure a differential switch is installed upstream.**

**Make sure the fan coil is earthed.**

To avoid electric shock, make sure the unit is earthed and the earthing wire is not connected to the gas or water pipe, to the lighting cable or to the telephone earthing wire.

**Do not operate the fan coil with wet hands.**

Otherwise this could cause an electric shock.

**Do not touch the heat exchanger fins.**

These fins are sharp and can cut and/or scrape the user.

**Do not place objects that can be damaged by moisture under the indoor unit.**

Condensate may occur if moisture exceeds 80%, if the drain outlet is blocked or if the filter is obstructed.

**After prolonged use, check that the unit's fittings are not damaged.**

If they are damaged, the unit may fall and injure the user.

**Install a drain pipe to ensure proper drainage.**

Incomplete drainage could cause water leaks in the building, etc.

**Do not touch the internal parts of the control device.**

Do not remove the front panel. Some internal parts are dangerous and could cause the machine to malfunction.



**Do not expose children, plants or animals to the direct flow of air.**

The direct flow could have negative effects on children, animals and plants.

**Do not operate the fan coil when a fumigation insecticide is being used.**

Failure to comply with this may result in chemicals being deposited inside the unit, with consequences to the health of those using such substances.

**Do not place electrical appliances that can produce open flames in areas exposed to the flow of air coming from the unit or under the indoor unit.**

The heat could cause incomplete combustion or deformation of the unit.

**Do not install the fan coil in areas subject to flammable gas leaks.**

A gas leak or gas staying near to the fan coil could start a fire.

**Do not spray or pour water or other liquids into the unit.**

Otherwise this could cause a serious electrical discharge.

**Do not use or spray cleaning liquids or aerosols. Use a soft dry cloth to clean the unit.**

Otherwise this could cause a serious electrical discharge.

Do not use detergents in the unit. Solvents can quickly destroy the unit's elements (drip tray and heat exchanger parts).

**Note:** for adequate performance, use the unit within the operating temperature and humidity conditions specified in this manual. If the unit is used outside these indications, this may cause the unit to malfunction or the indoor unit to drip.

**Cleaning the air filter.** A clogged air filter reduces cooling power. Clean it once a fortnight.

**Make air circulation in the room uniform.** Adjust the direction of air flow so that circulation in the room is consistent.



## 1.2 INSTALLATION.

### Dimensional drawing

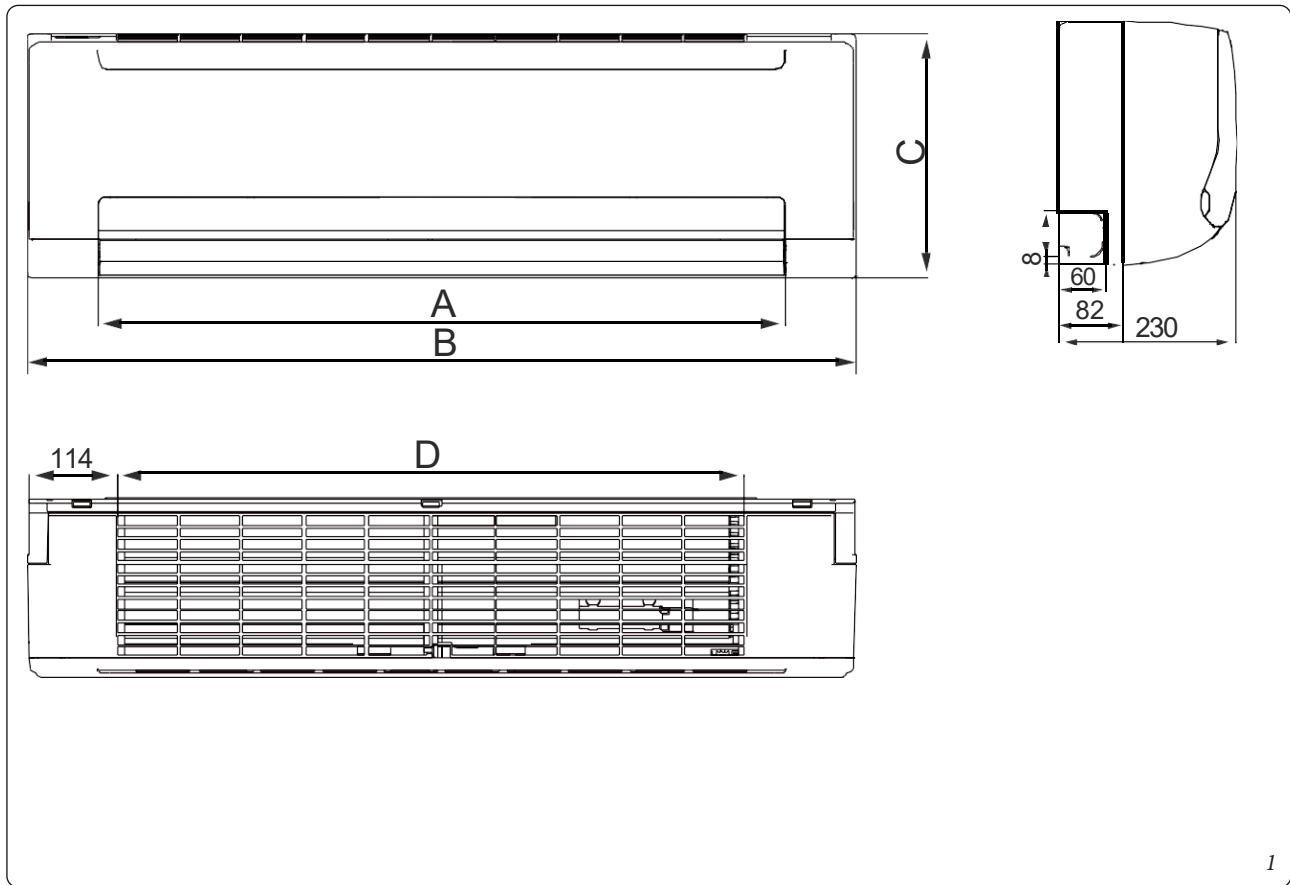

**Strictly follow these instructions to install the indoor unit or its pipes.**

**If the fan coil is to be installed on a metal part of the building, it needs to be electrically isolated in compliance with the applicable regulations on electrical appliances.**

**When all installation operations have been completed, carefully check and connect the supply voltage.**

**If the product is improved or modified, this manual will be subject to variations without forewarning.**

The fan coil must be installed in compliance with national wiring regulations to avoid the risk of death.

**Make sure the device is installed, repaired or serviced only by experienced and qualified staff.**

Incorrect installation, repairs or maintenance can cause electric shock, short circuit, water leaks, fires or otherwise damage the device.

**Strictly follow the instructions in this manual to install the appliance.**

Incorrect installation of the device can cause water leaks, electric shocks or fires.

**Use the accessories provided and the specified parts for installation.**

Otherwise this could cause a water leak, an electric shock or a fire.

**Install the unit on a steady, strong support that can withstand the weight of the device.**

Otherwise the unit could fall and cause damage and injury.

**The unit must not be installed in the laundry room.**

**Before opening the terminals, disconnect all supply voltage circuits.**

**When installation is complete, make sure there are no water leaks.**

The temperature of the cold water in the unit must not be less than 3°C, while that of the hot water must not exceed 70°C. The water in the unit must be clean and the water quality must comply with the PH standard=6.5~7.5.

**As the circuit temperature is high, install the connection cable away from copper pipes.**



**Take all necessary precautions during installation in the event of strong winds or any atmospheric or telluric calamities.**

Improper installation can cause the unit to fall and damage property or injure people.

**Do not install the fan coil in:**

- **Environments that contain petrolatum (e.g. petroleum jelly, petroleum distillates).**
- **Environments with salty air (near coasts).**
- **Environments with caustic gases (e.g. sulphur) in the air (near spa areas).**
- **Environments subject to strong voltage variations (in factories).**
- **Bars or cabinets.**
- **Kitchens with large amounts of diesel.**
- **Environments with strong electromagnetic waves.**
- **Environments with flammable materials or gas.**
- **Environments with acidic or alkaline liquids in evaporation.**
- **Other particular conditions.**

When installation is complete, make sure the unit works properly when started up.

Provide the customer with all information required for correct operation and maintenance of the unit.

**Order of installation:**

- Choose the installation point;
- Install the indoor unit;
- Install the pipes;
- Install the drain pipe
- Connect the vent pipe;
- Wire the unit;
- Test operation.

### **1.3 HYDRAULIC CONNECTION.**

**Following the instructions further on in the manual, install the pipes to ensure optimal drainage and insulate them to prevent condensate from forming.**

Incorrect drain pipes can cause water leaks and damage the device.



#### 1.4 WIRING.

Do not connect the fan coil to the supply voltage until wiring has been completed and the pipes have been connected.

##### Earth the fan coil.

Do not connect the earthing cable to the gas or water pipes, to the lighting cable or to the telephone earthing wire. Incomplete earthing can cause an electric shock.

##### Install a differential switch.

Failure to install this circuit breaker can cause electric shocks.

**Install the indoor units, wire the supply voltage and connect the cables at a minimum of 1 metre from the television or radio so as to prevent interferences or noises in the images.**

Based on the type of radio waves, a distance of 1 metre may not be far enough to completely eliminate the noise.

**For electrical work, comply with the national and local regulations on wiring and follow these installation instructions. Use a dedicated electrical circuit for power supply.** If the capacity of the electrical circuit is insufficient or is faulty, this could cause an electric shock or a fire.

**Use the specified cable, connect it and fasten it firmly to prevent any external force from interfering on the terminal.**

Incorrect connection or improper fastening of the wire may result in overheating or a connection fire.

**Prepare the wiring traces properly so that the control panel cover can be correctly fixed.**

Incorrect fastening of the control panel cover can cause overheating at the terminal connection point, a fire or an electric shock.

**If the power cable is damaged, it must be replaced by the manufacturer, by one of its specialised technicians, or by another qualified person in order to prevent any risk.**

**A multiple switch with a contact opening distance of at least 3 mm in all poles must be inserted on the product mains supply in accordance with the national installation rules in force.**

#### Indoor unit supply voltage 220-240V~50Hz

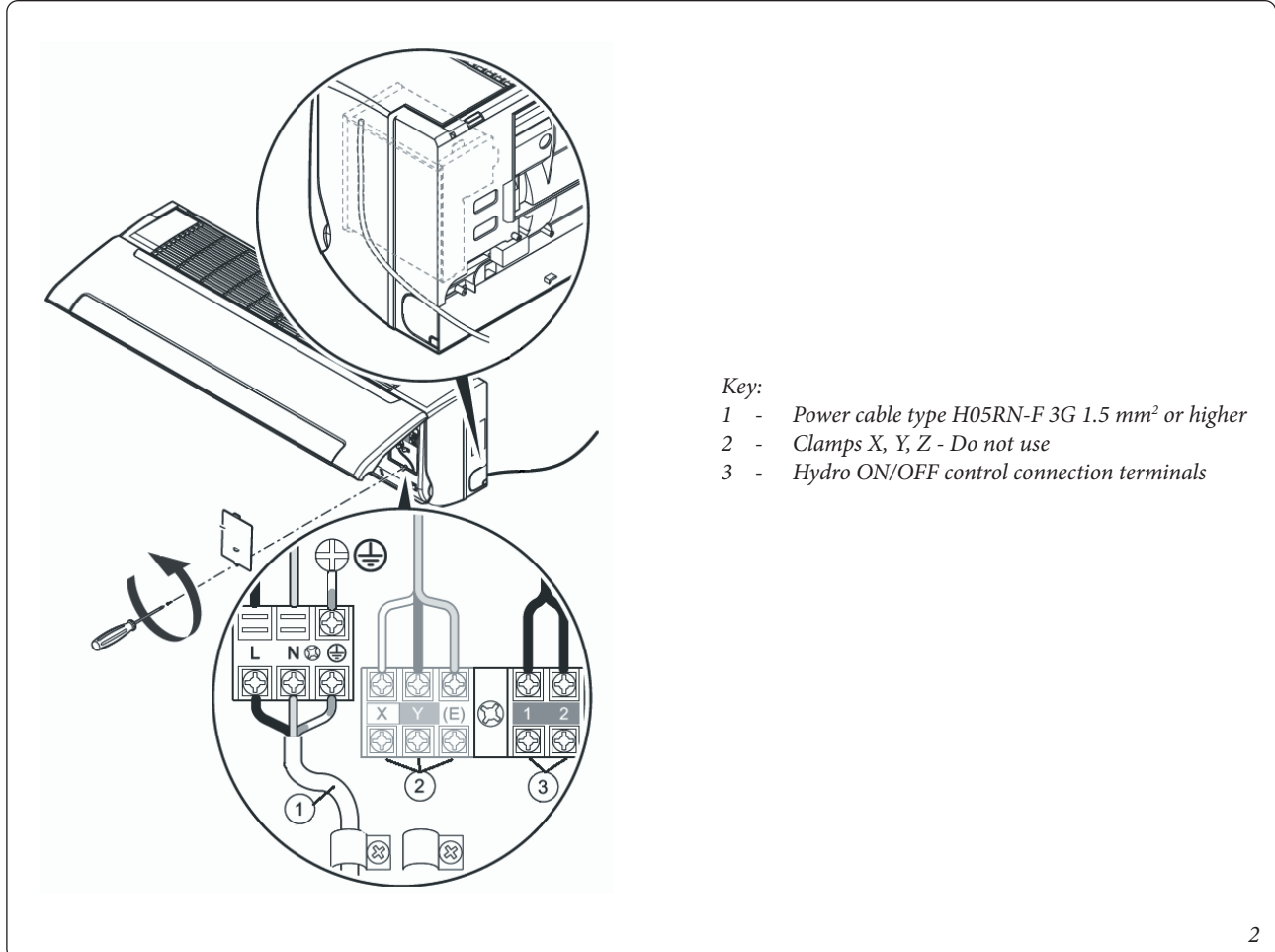

## Fan coil wiring diagram.

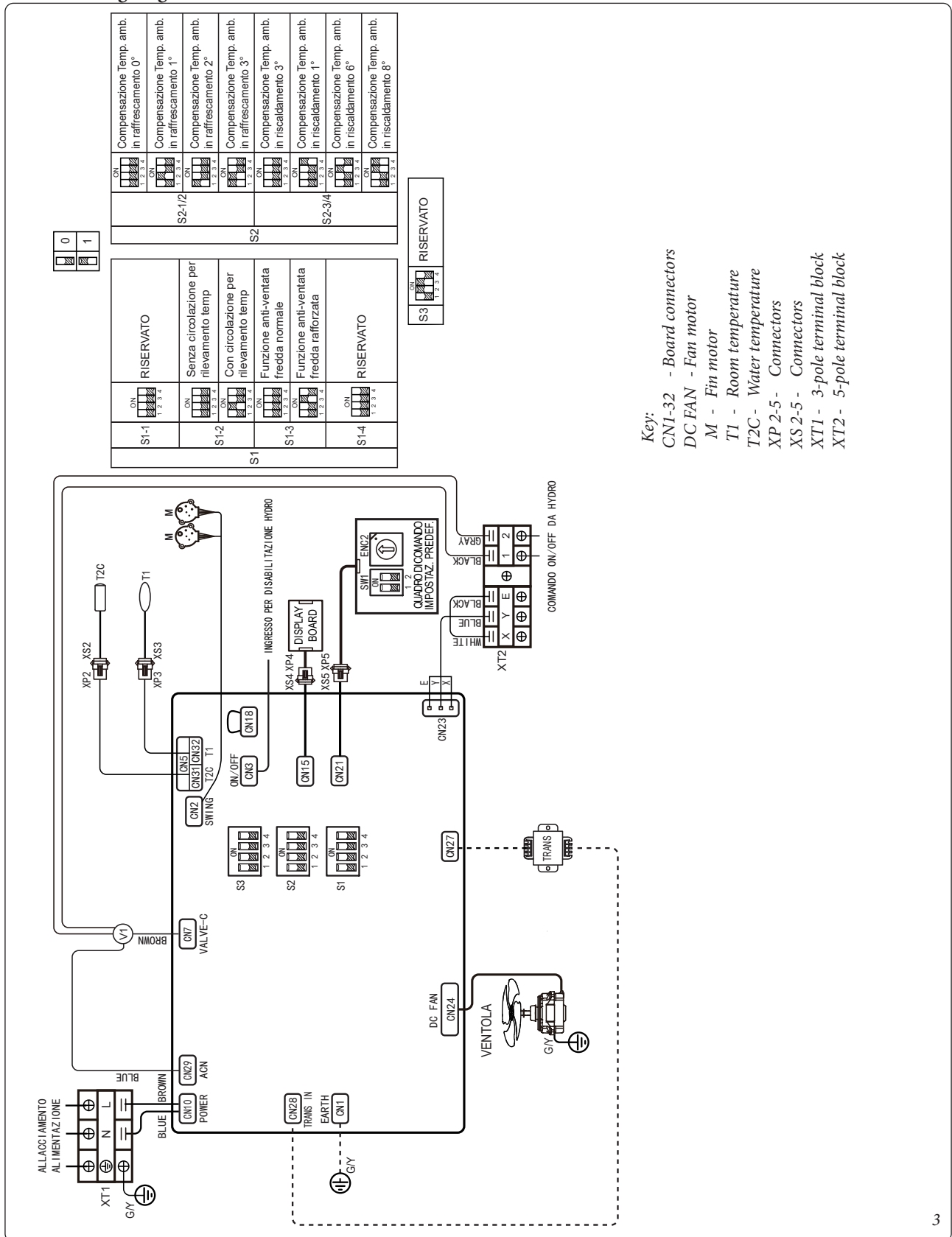

### Circulation for temperature detection

If activated, it allows air to circulate at low speed at regular intervals for more precise control of the room temperature.

### Temperature offset for valve closure

Allows you to select at which temperature below/above the set point to close the 3-way valve.

### Anti-cold blast function

It prevents the unit from staying on in heating mode when the inlet water temperature is too cold



## 2 INTRODUCING THE PRODUCT

### 2.1 IMPORTANT ADVICE.

#### Inspecting and handling the unit.

Upon delivery, check the packaging and immediately report any damage to the shipping company.

Consider the following when handling the unit:

-  Fragile, handle with care.
- Choose the route for transporting the unit in advance.
- Move the unit in its original packaging, if possible.
- Use special protective devices when lifting the unit so as not to damage the belts, and pay attention to the position of the unit's centre of gravity.

We recommend you strictly follow these instructions.

**The product warranty is rendered null and void if the above instructions are not complied with.**

**The manufacturer declines any liability for any faults to the product resulting from transport or handling not complying with the above recommendations.**

### 2.2 TECHNICAL FEATURES.















Features	Unit of measurement	Min	Max
Operating pressure	Mpa	0.15	1.6
Relative humidity	R.H. %	0	90
Cooling water inlet temperature	°C	3	20
Heating water inlet temperature	°C	30	70
Cooling indoor ambient air temperature	°C	17	32
Heating indoor ambient air temperature	°C	0	30



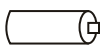

### 2.3 ACCESSORIES PROVIDED.

Make sure the package contains all of the installation accessories.

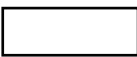
Name	Figure	Quantity	Function
Screw ST3.9x25 for installation panel with plugs		8	Fixing the installation panel
Plastic foam pipe		8	
Wrapping tape		1	
Drain pipe Ø 20		1	
L Type mounting plate		2	
Mounting screw (ST3.9 X 16-C-H)		2	Fixed I type mounting plate
Wall-mounted pipe cover		1	
Remote control		1	
Remote control mount		1	Remote controller holder
Mounting screw (ST2.910-C-H)		2	Installing the remote control mount
Alkaline batteries (AAA)		2	For the remote control
Cable for ON/OFF switch		1	
Installation manual		1	This manual
Gasket		4	For connecting the water pipe
Anti-condensation adhesive insulation		1	Prevent the walls from getting damp



2.4 COMPONENTS.

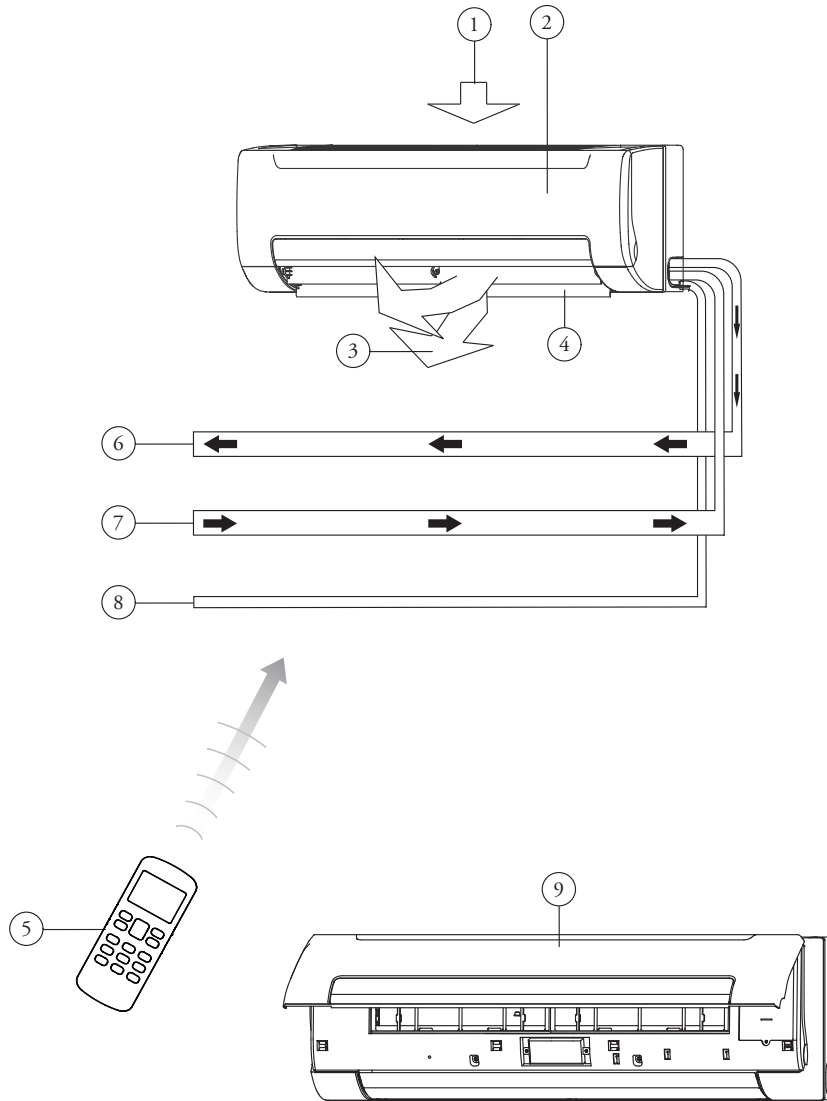

**NOTE**  
**The device is equipped with a 3-way valve.**  
**It is recommended to arrange the balancing valves on the hydraulic circuit.**

*Key:*

- 1 - Air inlet
- 2 - Front panel
- 3 - Air outlet
- 4 - Horizontal fins
- 5 - Remote control

- 6 - Water return pipe
- 7 - Water inlet pipe
- 8 - Drain pipe
- 9 - Front panel



# 3 INSTALLATION

## 3.1 INSTALLING THE INDOOR UNIT. PLACE OF INSTALLATION.

**Installation in the places listed below could be problematic. If this is unavoidable, call your local dealer.**

- Environments with large quantities of machine oil.
- Salty environments, such as coasts.
- Environments with high amounts of sulphur gases, such as spa areas.
- Environments with high frequency machinery, such as wireless equipment, welding machines and medical facilities.
- Environments that contain oxidising gases and volatile matter.
- Environments with particular environmental conditions.
- Environments with obstacles near the entrance and exit areas.
- Environments not suitable for maintenance.
- Environments that have no space indicated in the diagram around the indoor unit.
- Environments with strong electromagnetic waves.
- Environments near sources of heat, steam and flammable gasses.

## DRILLING THE WALL AND MOUNTING THE INSTALLATION PANEL.

Installation panel and right way up (unit: mm) (Fig. 5 and 6).

### • Fixing the installation panel (Fig. 7)

- Apply the anti-condensation adhesive insulation on the back of the unit's metal installation plate to prevent the formation of moisture on the wall (Fig. 8).
- Install the panel horizontally on the structural parts of the wall using the specific plate.
- If the wall is in brick, concrete or similar, drill 5 mm diameter holes. Insert the plugs for the mounting screws.
- Fix the installation panel on the wall.

### • Drilling the wall

- Determine the position of the pipe hole using the installation panel and drill a hole ( $\varnothing 95$  mm) so that the pipe slopes slightly downwards.
- Use a special guide for drilling metal rods, laminated wood or metal plates.



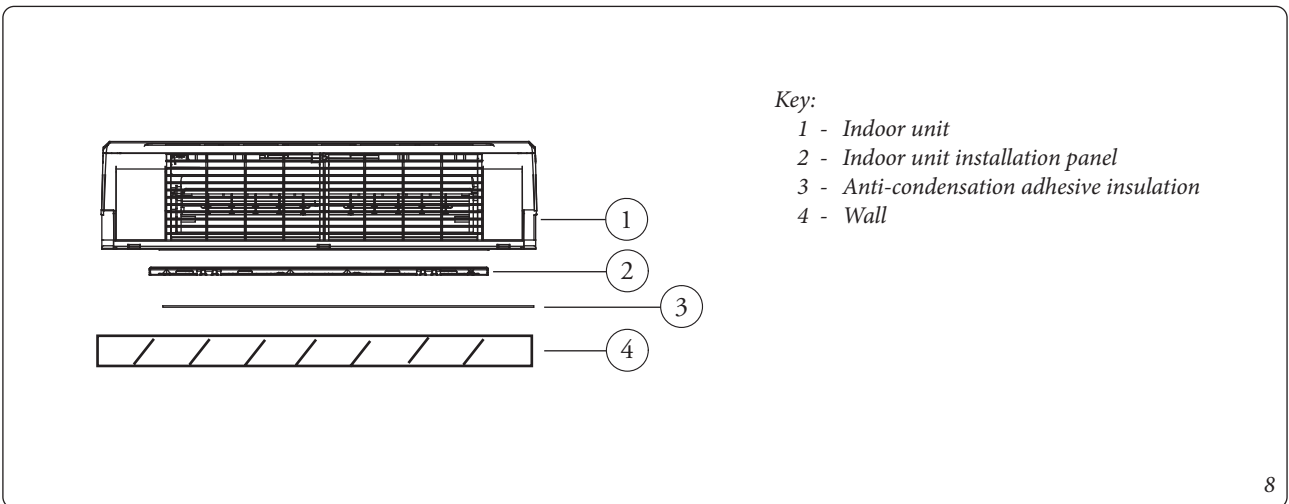
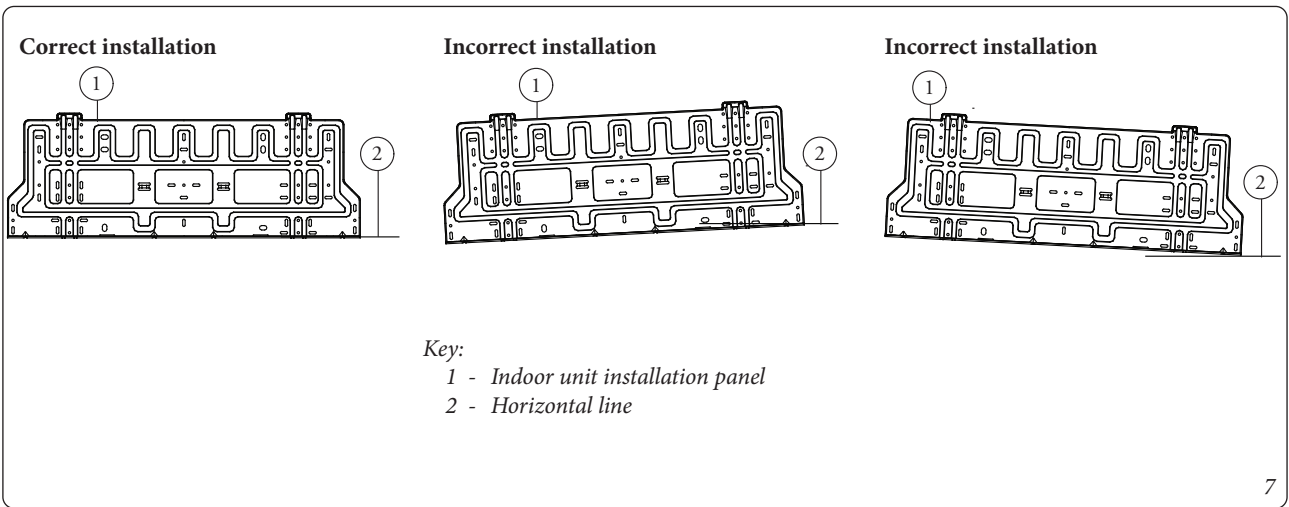
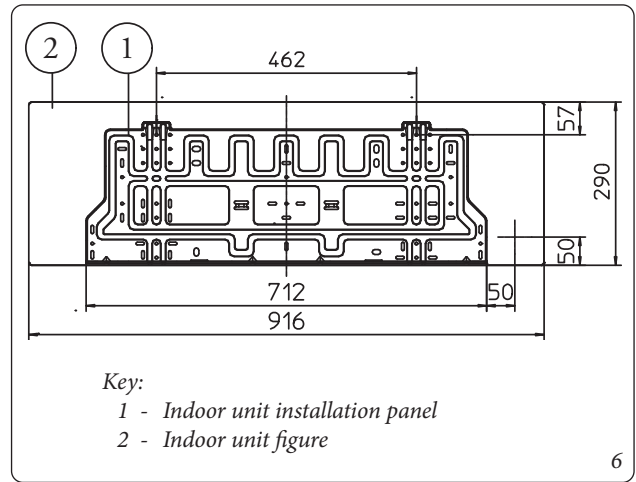
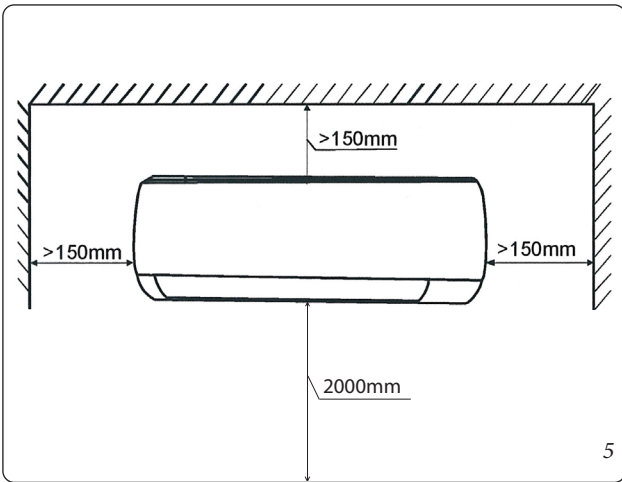

## INSTALLING THE CONNECTION AND DRAIN PIPES

### • Drainage

- Insert the drain pipe so that it slopes slightly downwards. Fig. 9 indicates the suitable installation and those not allowed.
- When connecting the drain pipe, insulate the part connecting the extension with a rigid plastic pipe that is supplied (Fig. 10).

### • Connection pipe (Fig. 11)

- Install the left and rear left pipes as shown below. Bend the connection pipe to a height of 43 mm or less from the wall.
- Secure the end of the connection pipe (see the tightening procedure in the section on INSTALLING THE WATER PIPES). When connected, cover all of the pipes with heat-resistant material.

**Note:** bend and position the pipe carefully.

Ensure the pipe does not protrude from the back of the indoor unit.

Make sure the drain pipe is connected correctly.

Isolate the flow and return pipes.

Pass the drain pipe under the flow and return pipes.

In case of connections with flow and return pipes coming from the left side (looking at the split from the front), it is recommended to use a box for the preparation of recessed hydronic split, to avoid having walled joints.

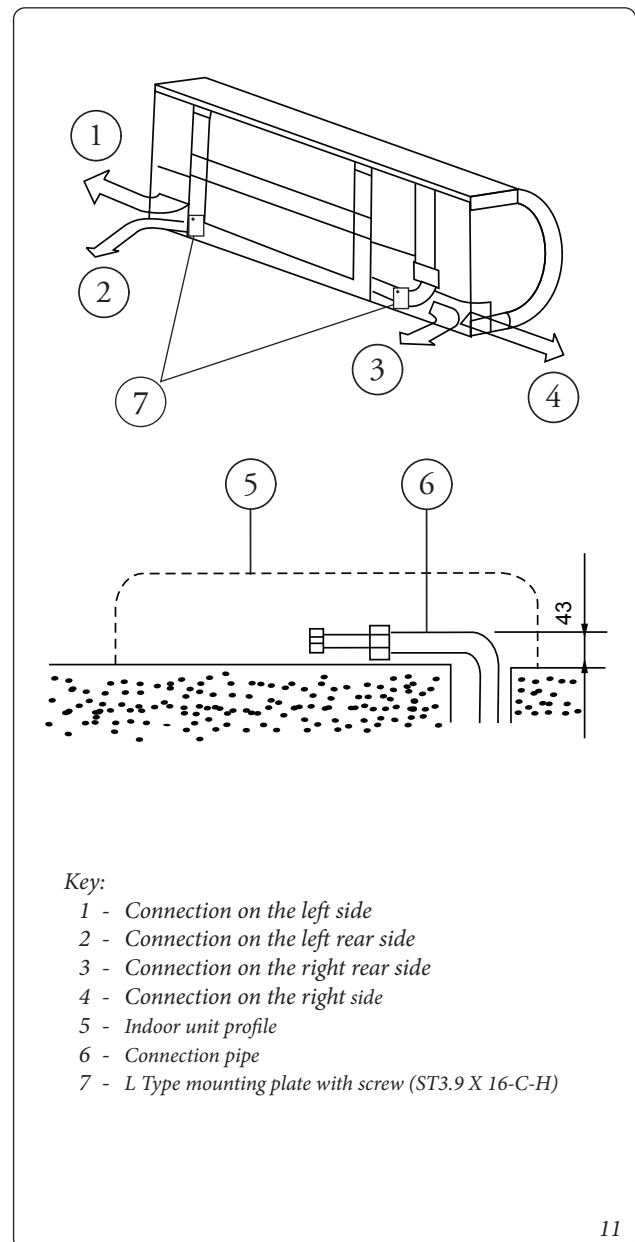
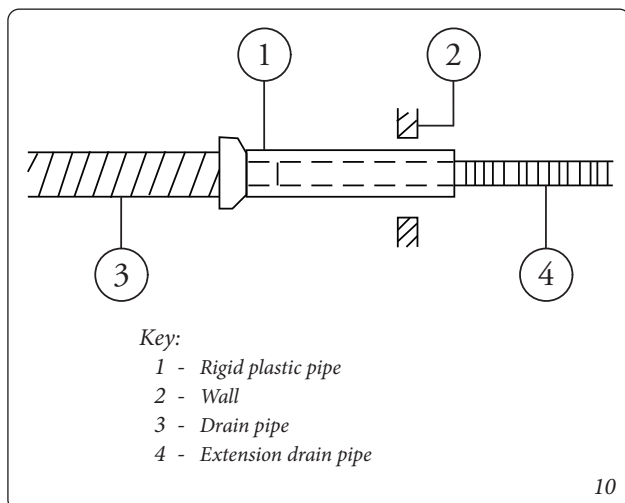
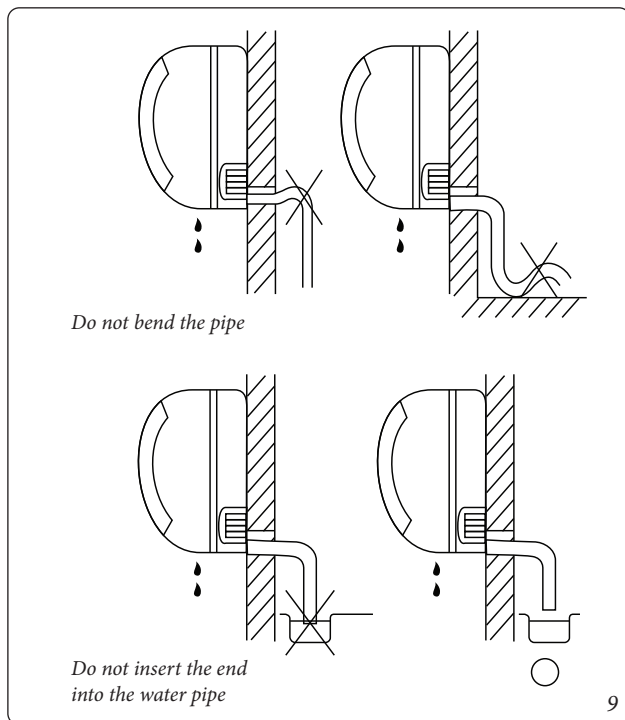

• **Connecting the pipes and binding them (Fig. 12)**

Wrap the connection cable, the drain pipe and wires securely and evenly with tape, as shown below.

- The condensed water generated at the back of the indoor unit is collected in a special tank and conveyed outside the room. Do not put anything else in the tank.

**INSTALLING THE INDOOR UNIT (Fig. 13)**

- Pass the piping through the hole in the wall.
- Place the indoor unit on the hook of the installation panel, move the indoor unit sideways and make sure it is safely attached.
- The pipes can quickly and easily be connected by lifting the indoor unit with cushioning material placed between the unit and wall. Remove when the pipes have been connected.
- Push the bottom of the indoor unit upwards along the wall, then move the unit sideways and downwards to ensure it is safely attached.

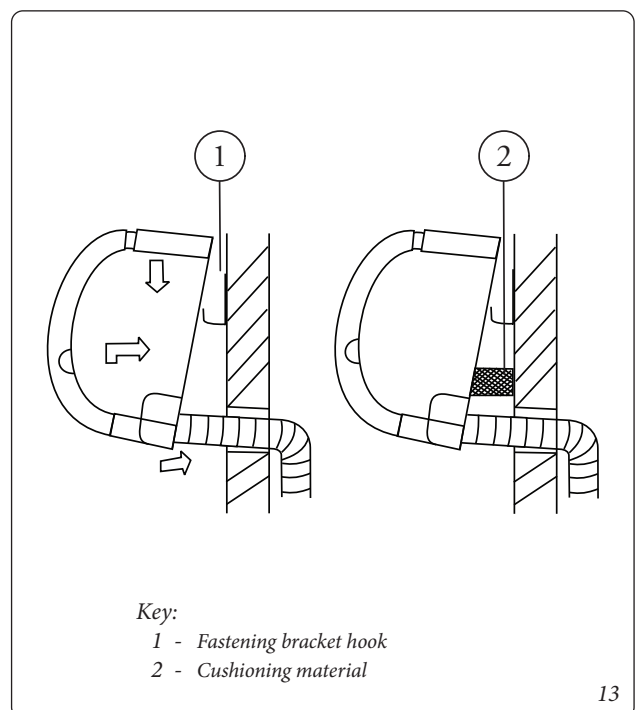
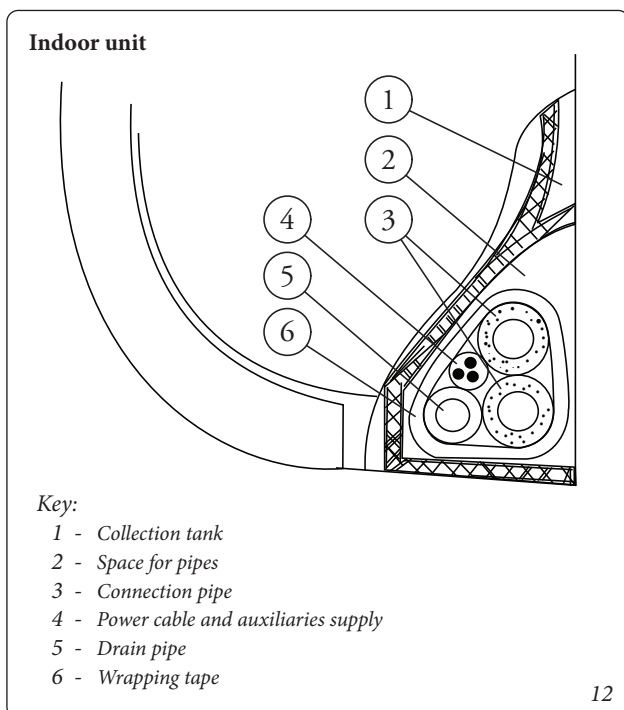

### 3.2 INSTALLING THE WATER PIPES.

#### CONNECTING THE WATER PIPE

The water pipe must be connected by expert technicians using two spanners for tightening the pipes of the indoor unit (Fig. 14).

- When connected for the first time, completely expel the air through the outlet valve (Fig. 15).

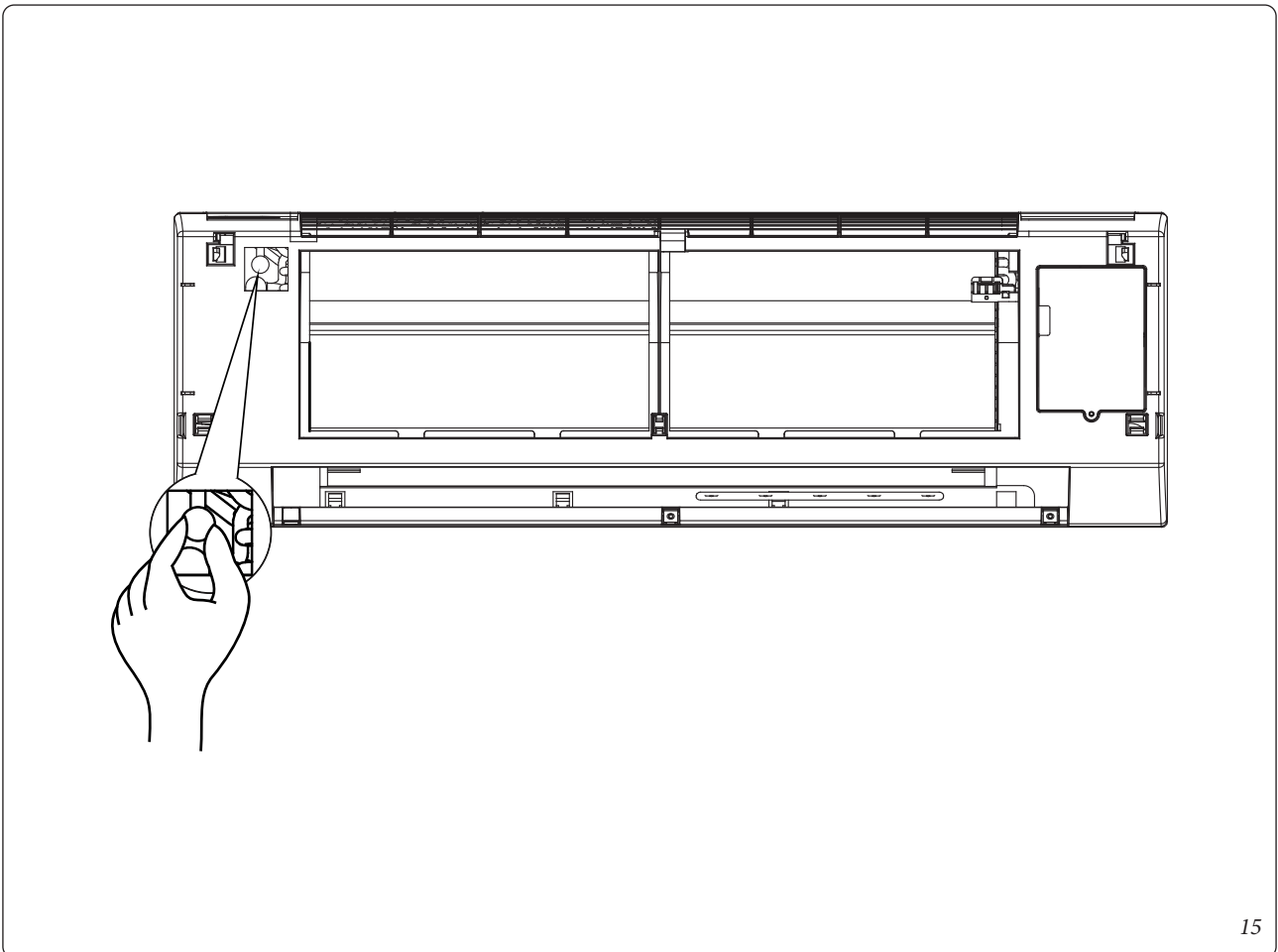
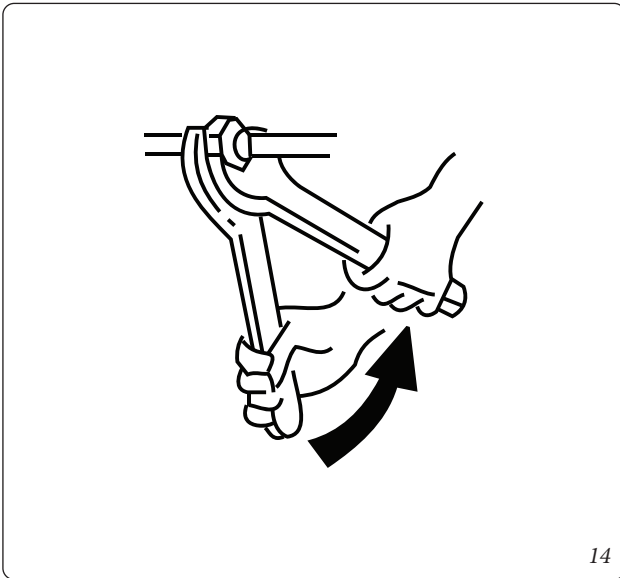



### 3.3 WIRING DIAGRAM.

Pursuant to applicable national regulations, fixed wiring must have an integrated single-pole disconnect device with a distance between contacts of at least 3 mm on all poles and a differential of at least 30 mA.

The device must be installed in compliance with the national regulations in force.

- Open the front protection (1) and remove the plate (2) by disconnecting the display connection cables (see box). (Fig. 16).

- Remove the panel and connect the power cable and the auxiliary lines, then configure, if necessary (Fig. 17).

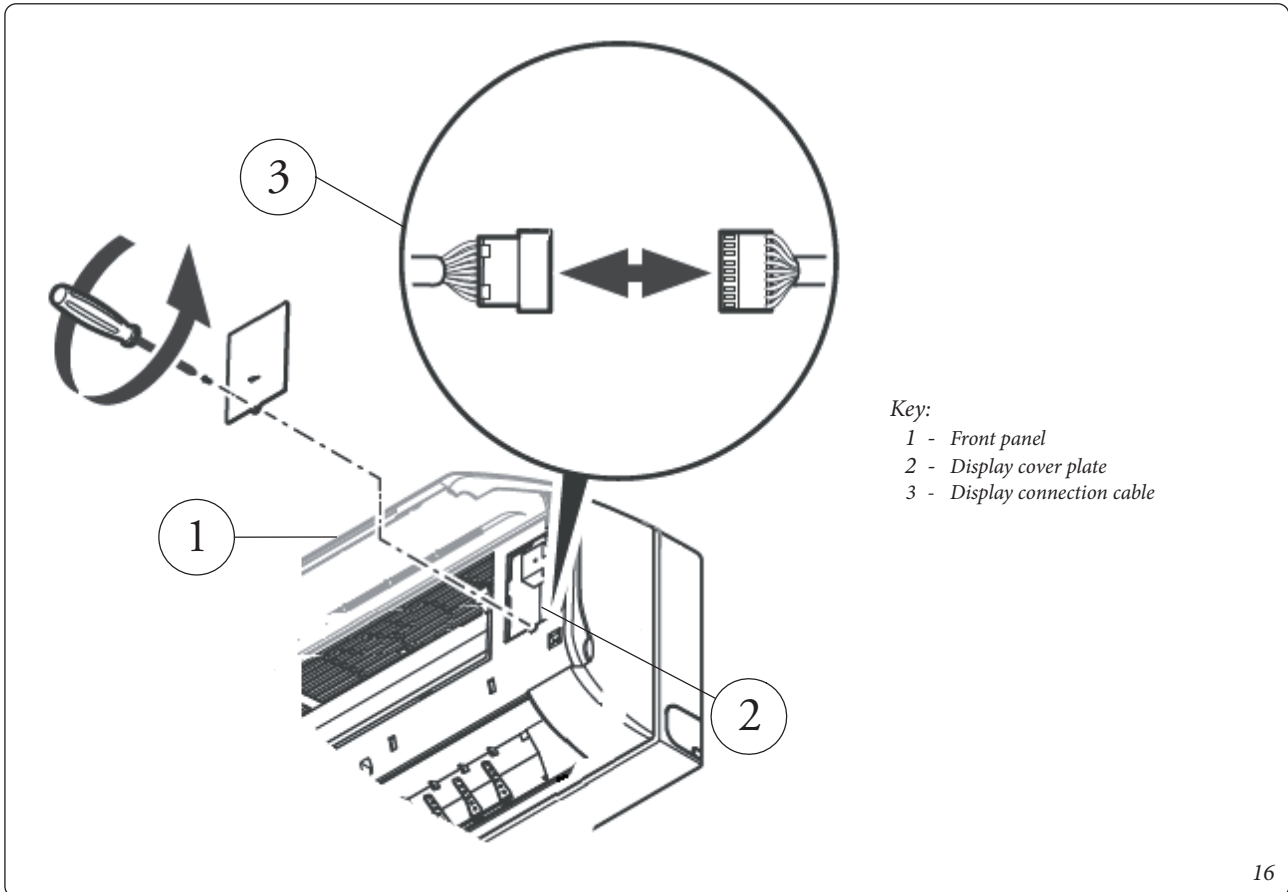

16

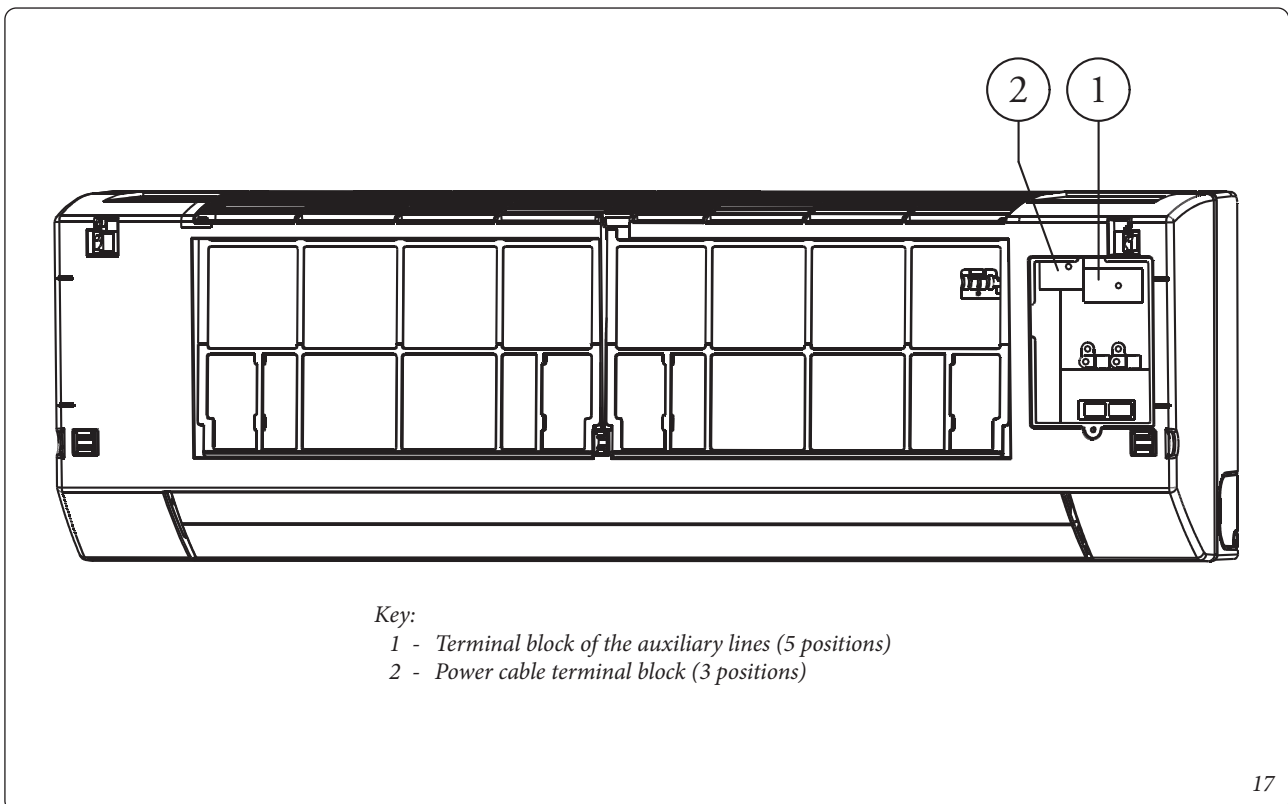

17



## TERMINAL BLOCK DIAGRAM

For wiring, refer to the wiring diagram for the indoor unit.

The power cable must be H05RN-F or higher with a minimum section of 1.5 mm<sup>2</sup>.

### **Input preset for Hydro disabling.**

The Hydro board requires an optional remote system disabling command; to use this function, you must connect the cable supplied with the unit, to the CN3 connector, as indicated in the wiring diagram of *Fig. 3* (the command must be supplied with a clean contact. If the contact is open, the system is controlled by the remote control; if the contact is closed, the unit remains forcibly off).

Make sure that the power supply is disconnected to connect the wiring. Then access the P.C.B. found below the terminal block area; access it by removing the front panel and removing the screws from the cover of the box containing the P.C.B..

Once the supplied wiring has been connected, it will be possible to close the board compartment and then connect the cable to the command, using terminals that are not supplied, to disable the

### **On/Off command from Hydro device.**

Potential free contact, supplied by Hydro, with a max charge of 700 mA.

The contact is closed if there is a request for hot/cold/dehumidification on the Hydro.

The contact remains open in the absence of requests.



### 3.4 COMMISSIONING.

- The test must be performed only after completing installation.
- Please check the following points before testing.
- The unit must be installed properly.
- Pipes and electrical cables must be connected properly.
- Pipes pressure test.
- Thermal insulation was done properly.
- Earthing was done properly.
- The supply voltage is the same as the design voltage for the fan coil.
- The unit's air inlet and outlet are not obstructed.
- The fan coil has been pre-heated with voltage.

#### Operating test

Use the remote control to set the fan coil in cooling mode and check the following points, as indicated in the part on use in this manual. If there is any malfunction, resolve it using the instructions in the “**Troubleshooting support**” section in this manual.

- Check that the unit switches on and off properly from the remote control.
- Check that all keys on the remote control work.
- Check that the deflectors or fins move properly.
- Check that the internal temperature is properly regulated.
- Check that the indicators on the receiver work properly.
- Check that the condensate drains regularly.
- Check whether there are vibrations or strange noises during operation.
- Check that the heating capacity is adequate.
- Check for water leaks.

### OPERATING RANGE

For safe and efficient operation, use the system with the following temperatures.

Temperature Mode	Room temperature	Inlet water temperature
Cooling	17°C ÷ 32°C	3°C ÷ 20°C
Central heating (without cooling)	0°C ÷ 30°C	30°C ÷ 70°C

Note: use of the fan coil outside the above conditions could cause anomalies and malfunctions of the device.

**Note:** if the relative humidity of the environment is very high, condensation may form on the surface of the fan coil. Close doors and windows.

**Note:** for optimal performance, use the device within the temperature range indicated.

**Note:** water system operating pressure: Max: 1.6MPa, Min: 0.15MPa.

### ENERGY SAVING TIPS

Read below for energy-efficient operation.

- Adjust the flow grid appropriately and avoid direct air flow on users.
- Adjust the room temperature appropriately. Avoid excessive heating or cooling.
- Block direct sunlight during cooling operations with curtains or blinds.
- Using the unit does not guarantee ventilation of the environment.
- Keep doors and windows closed. If doors and windows stay open, the air will escape from the room and reduce the heating or cooling effect.
- Do not place objects next to the unit's air inlet and outlet to prevent the effects from falling or stopping the device.
- Set the timer.
- In case of long downtime, remove the batteries from the remote control. When the supply voltage is connected, a small amount of energy is used up even if the fan coil is not working. Disconnect the supply voltage to save energy.
- Keep the indoor unit and the remotecontrol at least 1 m away from televisions, radios, stereos, and other similar devices. Failure to comply with the above may result in static or distorted images.
- Clean the air filter at least once every fortnight to prevent the dirt inside from reducing cooling or heating efficiency.



### ADJUSTING THE AIR FLOW DIRECTION

When the unit is working, the flow grid can be adjusted to change the flow direction and make the room temperature more homogeneous. This way, room comfort will also increase.

- **Adjust the horizontal air jet** (Fig. 18).

Use the remote control to adjust the horizontal air deflector.

- Adjust the air jet in the vertical position. Open the horizontal air deflector and manually adjust in the vertical position.

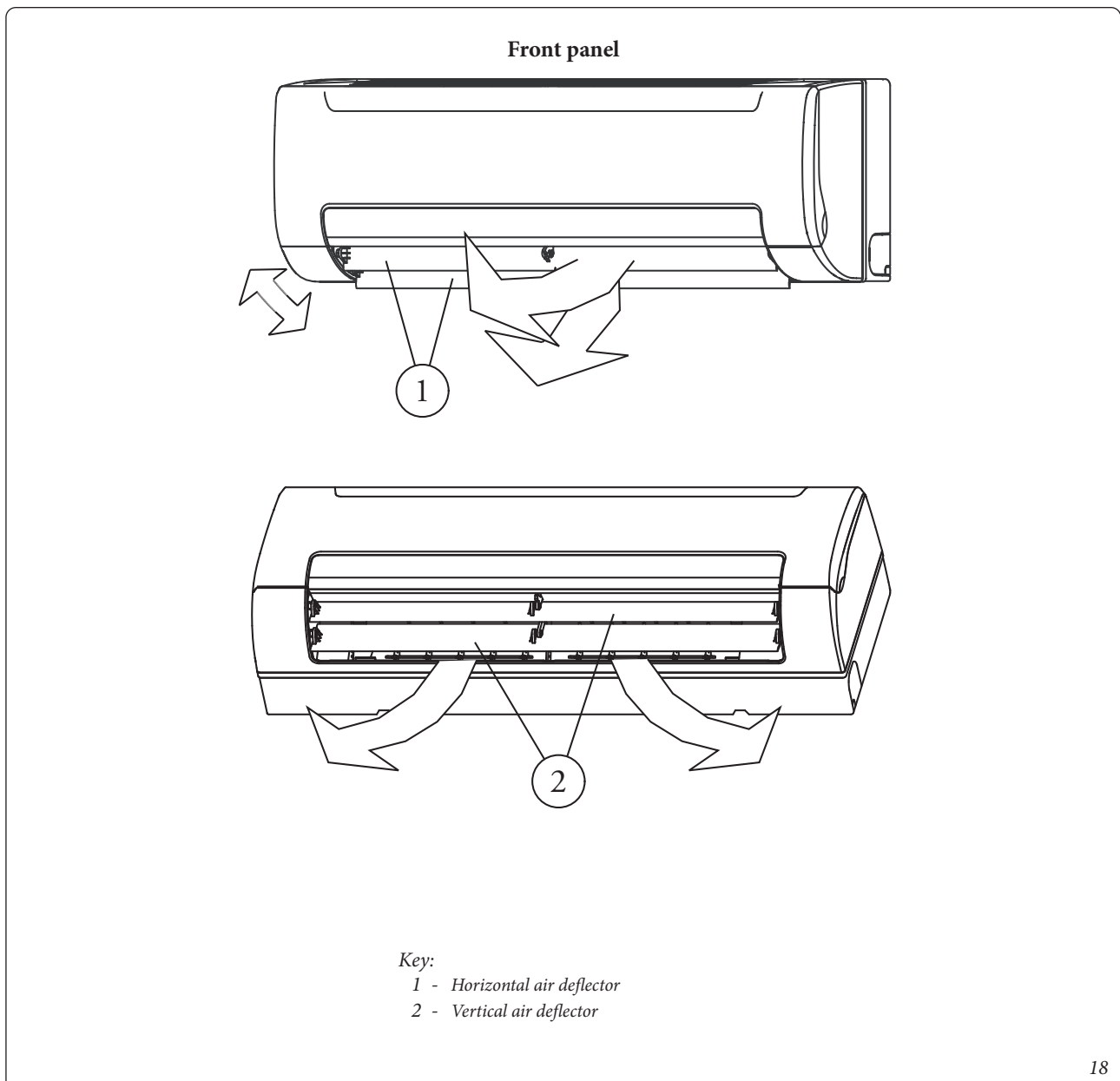

# 4 PARAMETER SETTINGS / USE

## 4.1 PRECAUTIONS WHEN INSTALLING THE REMOTE CONTROLLER.

### 4.1.1 SAFETY CONSIDERATIONS.

Please read this "Safety Considerations" carefully before installing Controller and be sure to install it correctly. After completing the installation, make sure the controller operates properly.

Please instruct the customer how to operate the controller and how to perform maintenance.

### 4.1.2 MEANING OF CAUTION SYMBOLS.



Failure to observe these instructions properly may result in property damage or personal injury.

Information classified as **NOTE** contains instructions to ensure proper use of the controller.



- Ensure that nothing interrupts operation of the wireless remote controller.
- Ensure that the signal from the remote controller can easily be transmitted.
- Ensure that the operation display lamp and other indicator lamps can easily be seen.
- Ensure that there is neither a source of light nor a fluorescent lamp near the receiver.
- Ensure that the receiver is not exposed to direct sunlight.

### 4.1.3 PRECAUTIONS IN HANDLING REMOTE CONTROLLER.

- Direct the transmitting part of the remote controller to the receiving part of the air conditioner (*Fig. 19*).
- If something blocks the transmitting and receiving path of the indoor unit and the remote controller as curtains, it will not operate.
- Transmitting distance is approximately 7 m.
- 1 short beeps from the receiver indicates that the transmission is properly done.
- Do not drop or get it wet. It may get damaged.
- Never press the button of the remote controller with a hard, pointed object.

The remote control may break.

### 4.1.4 INSTALLATION SITE.

- It is possible that signals will not be received in rooms that have electronic fluorescent lighting. Please consult with the salesman before buying new fluorescent lights.
- If the remote controller operated some other electrical apparatus, move that machine away or consult your dealer.

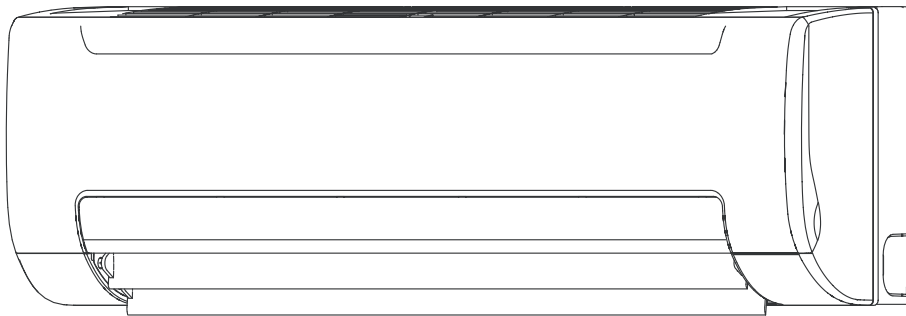

4.2 DIMENSIONS OF THE REMOTE CONTROLLER AND BRACKET.

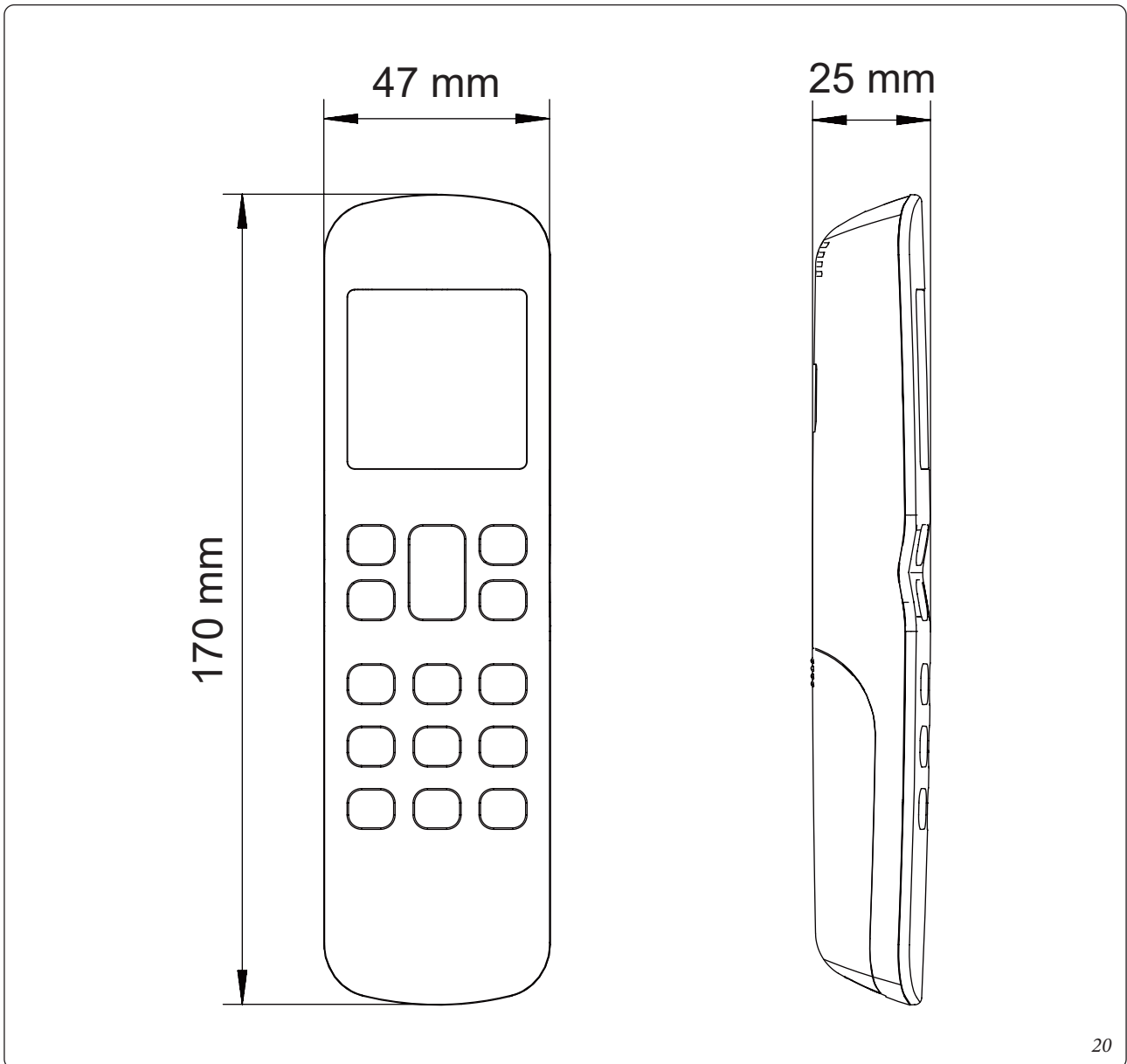

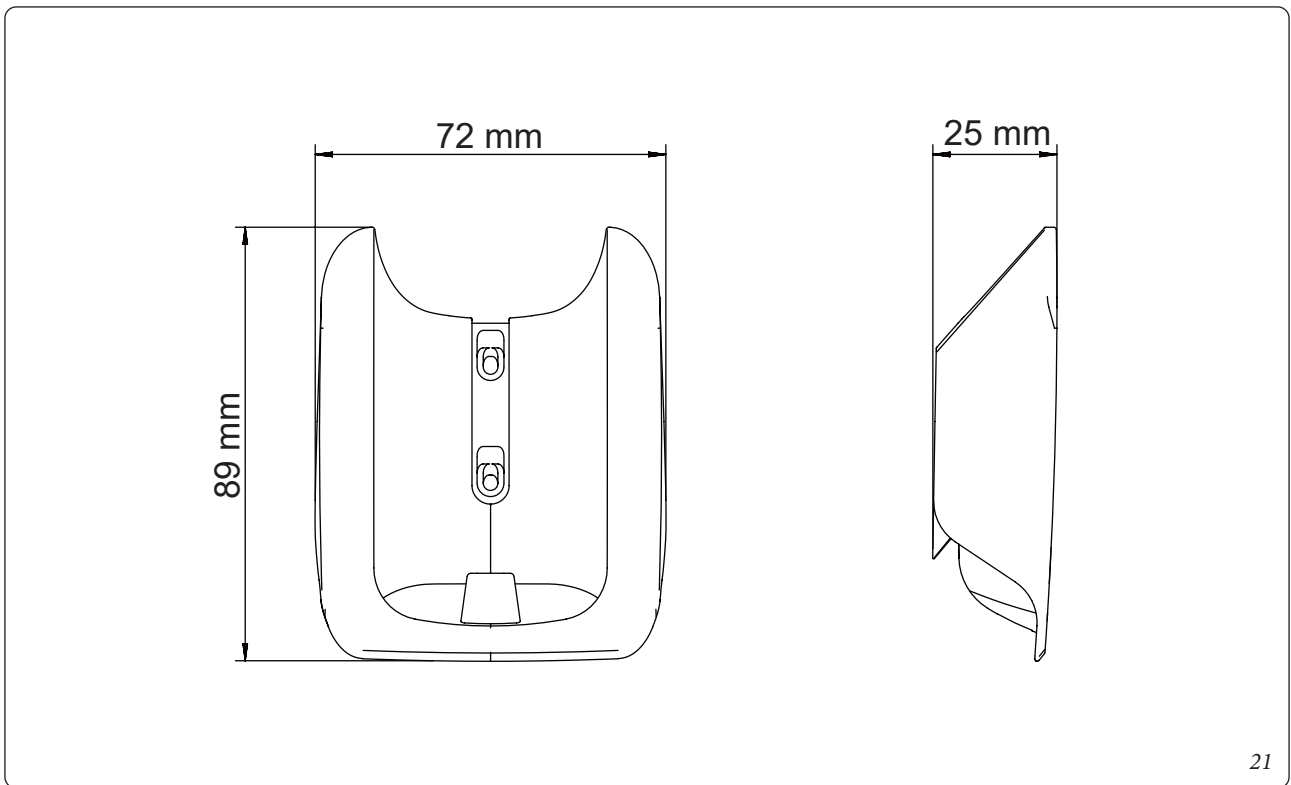

**4.3 INSTALLATION AND FIXING.**

1) Use the screws in the accessories to fix and secure the remote controller bracket in a stable position (Fig. 22).

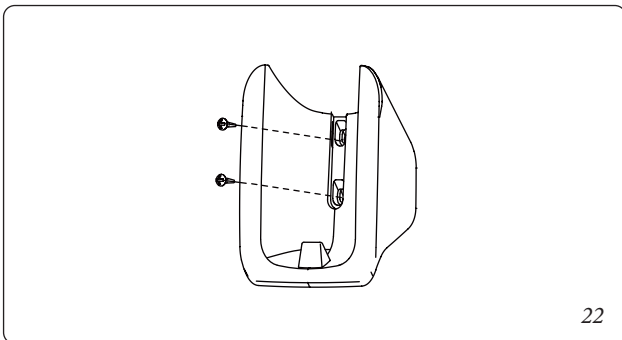

2) Slot the screw lid into the bracket cover on top of the screws (Fig. 23).

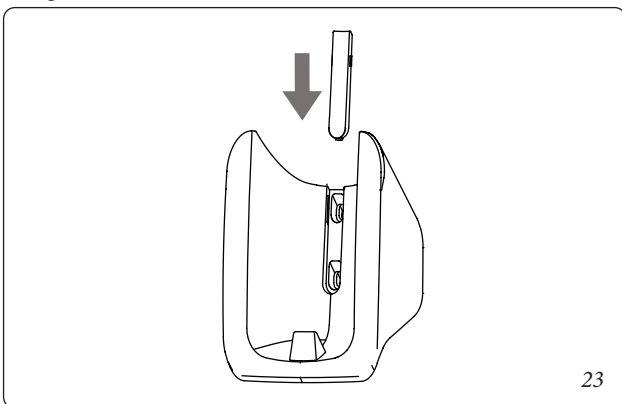

3) Slide the remote controller vertically down into the remote controller bracket (Fig. 24).

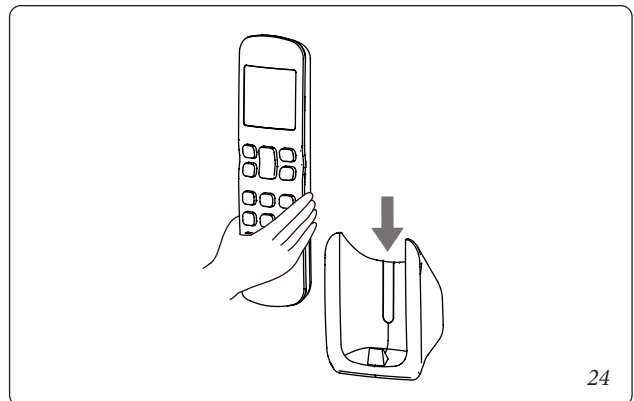



#### 4.4 REPLACE THE BATTERIES.

1) Slide to move the battery cover at the back of the remote controller in the direction indicated by the arrow (Fig. 25).

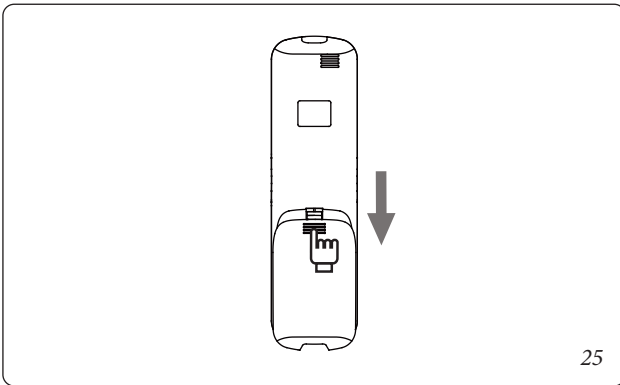

2) Lift up from the lower left end of the battery cover to open it (Fig. 26).

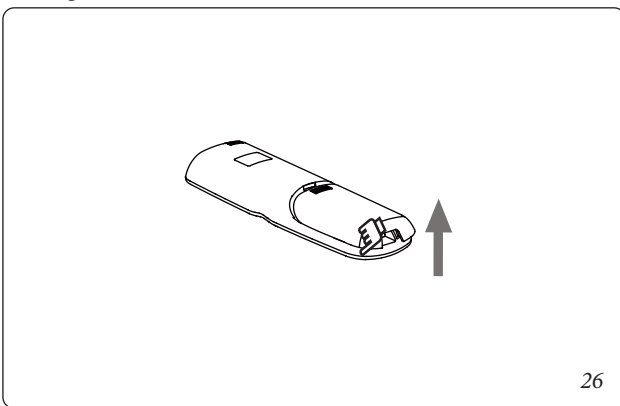

3) Take out the old batteries. Install two new AAA batteries according to the positive and negative polarities indicated (Fig. 27). Close the battery cover.

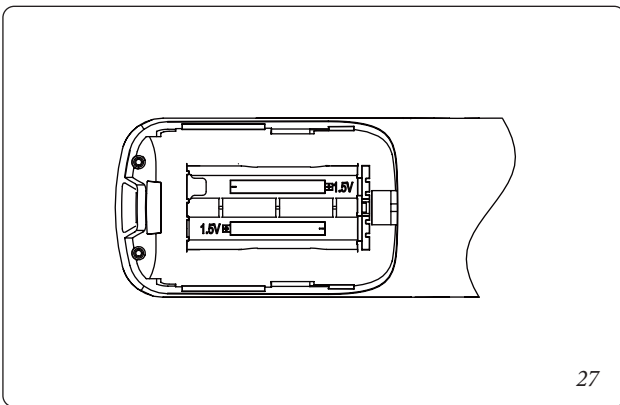

#### 4.5 OPERATING THE REMOTE CONTROLLER.

##### 4.5.1 USING PRECAUTIONS.

To gain full advantage of the controller's functions and to avoid malfunction due to mishandling, we recommend that you read these precautions before use.

The precautions described are classified as WARNING and CAUTION. They both contain important information regarding safety. Be sure to observe all precautions without fail.



##### WARNING

Failure to follow these instructions properly may result in personal injury or loss of life.



##### CAUTION

Failure to observe these instructions properly may result in property damage or personal injury, which may be serious depending on the circumstances.

Information classified as NOTE contains instructions to ensure proper use of the controller.

After reading, keep this manual in a convenient place so that you can refer to it whenever necessary. If the controller is transferred to a new user, be sure also to hand over the manual.



##### WARNING

Note that prolonged, direct exposure to cool or warm air from the air conditioner or to air that is too cold or warm can be harmful to your physical body and health.

- Do not use pesticides, disinfectants and flammable sprays to spray directly on the remote controller as these may cause the device to become deformed.
- If there is a fault with the remote controller, turn off the remote controller and contact your local agent.
- Remove the dry batteries before cleaning or maintenance of the remote controller. Do not wash the controller with water.











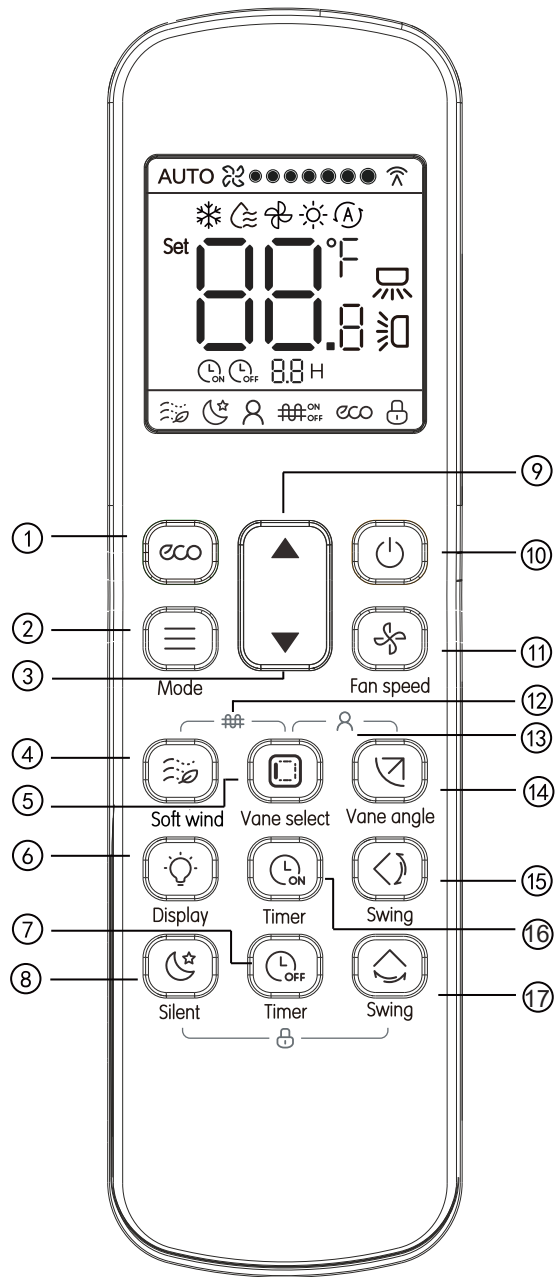







##### CAUTION

- Do not operate the device with wet hands to prevent water from entering the remote controller and damage the circuit board.
- Do not use the air conditioner for purposes other than those for which it is intended. Do not use the air conditioner to cool precision instruments, food, plants, animals or works of art as this may adversely affect the performance, quality, and/or lifespan of the object concerned.
- Ventilate the area from time to time. Be careful when you use the air conditioner with other heating equipment. Insufficient ventilation may result in oxygen deficiency.



4.6.2 BUTTON NAMES AND FUNCTIONS.



No.	Button	Function
1	 ECO	Turn on/off the economic operation function
2	 Mode	Set operating mode: Cooling -> Dehumidification -> Ventilation -> Heating
3	▼ Adjust downwards	Adjust the temperature setting or timer (programmed time) downwards
4	 Soft wind	Function not present on this model
5	 Vane select	Function not present on this model
6	 Display	Turn on or off the display of the indoor unit
7	 Timer switch-off	Set the time to turn off the unit
8	 Silent	Function not present on this model
9	▲ Adjust upwards	Adjust the temperature setting or timer (programmed time) upwards
10	 On/off switch	Switch on/off the unit
11	 Fan speed	Fan speed setting
12	 Auxiliary heater	Function not present on this model
13	 Follow Me Operations	Turn on/off the follow me function
14	 Vane angle	Adjust the angle of the horizontal louver
15	 Swing	Turn on/off the vertical swing function
16	 Timer switch-on	Set the time to turn on the unit
17	 Swing	Function not present on this model



**4.5.3 NAME AND FUNCTIONS ON DISPLAY SCREEN.**

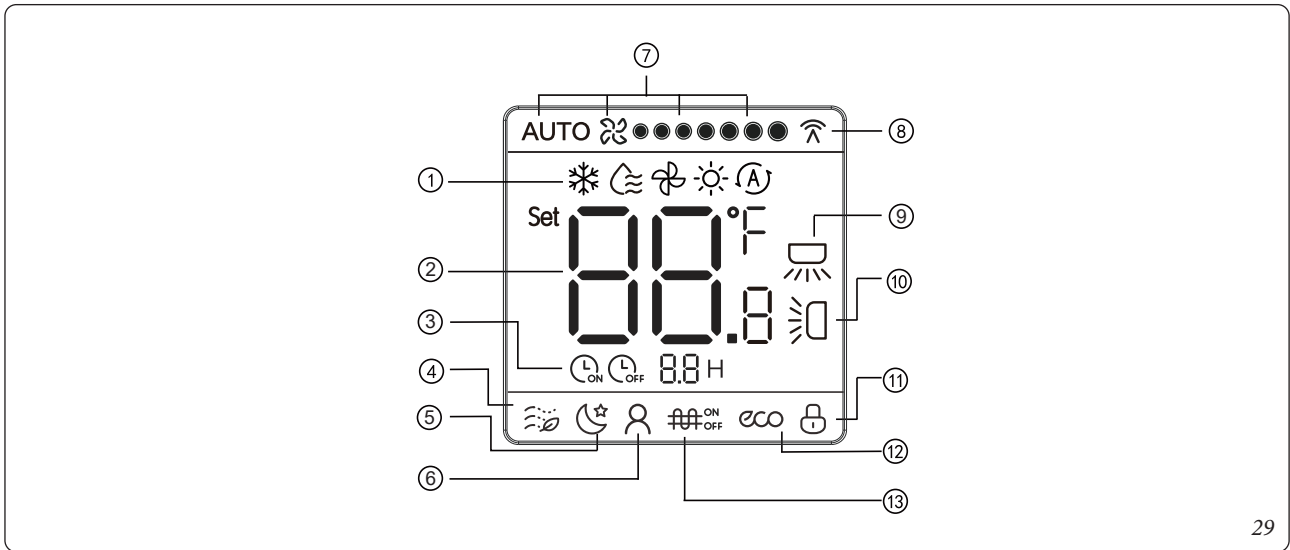

29

No.	Name	Function
1	Operating mode	Displays the current operating mode
2	Temperature	Displays current temperature setting
3	Timer On/Off Operations	Displays times to turn on/off the unit
4	Soft wind	Function not present on this model
5	Silent mode	Function not present on this model
6	Follow Me Operations	Shows that Follow Me is on
7	Fan speed	Displays the current fan speed
8	Signal transmission	Displays signal sent to the indoor unit from the remote controller
9	Horizontal swing	Function not present on this model
10	Vertical swing	Shows that Vertical Swing is on
11	Padlock	Indicates that the remote control buttons are locked
12	ECO	Shows that ECO function is on
13	Auxiliary heater	Function not present on this model



#### 4.5.4 OPERATING MODES.

##### On/Off Operations

1) Press  to start the indoor unit:

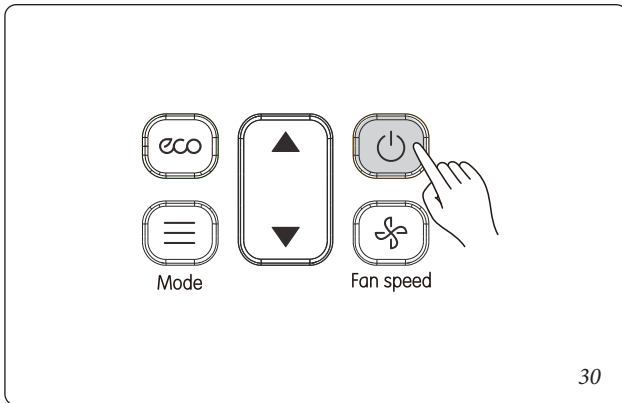

2) Press  again to stop the operation of the indoor unit. When the unit is off, the modes are visible on the display.

##### Mode and temperature.

1) Press . Display screen shows the operating mode:

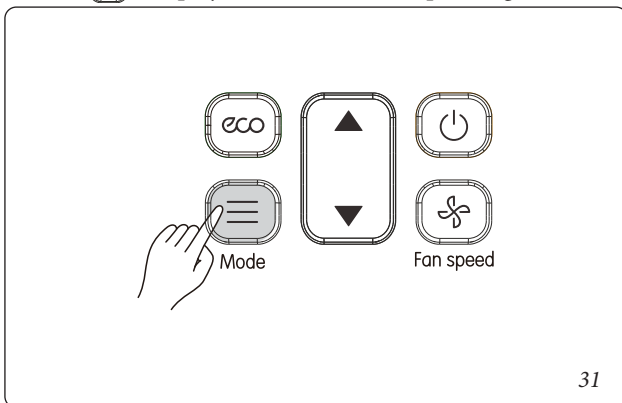

2) Press  each time to change the operating mode according to the order shown below:



3) In Cooling and Heating mode, press ▲ and ▼ to adjust the temperature setting. Press ▲ and ▼ to adjust the temperature by 1°C (default). Long press to change the temperature continuously.

##### Note:

- Temperature setting cannot be adjusted in the Ventilation and Dehumidification mode.

##### Fan speed.

Every time when you press the  button, fan speed is changed in the following order:

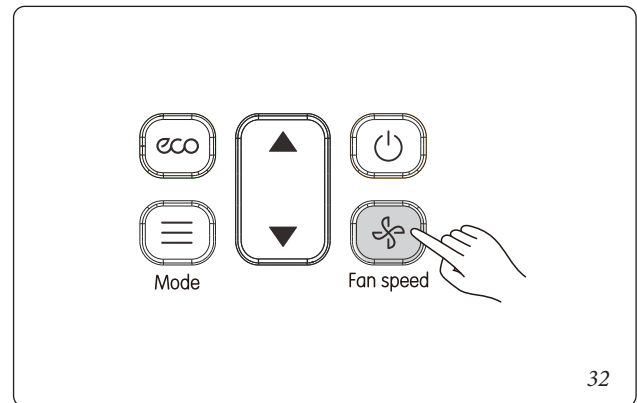



1) 3 speeds: the fan speed will be adjusted in turn as shown below:





##### Note:

- The fan speed set on the remote controller should match with the air conditioner. For how to set the fan speed, see section “Initial Settings”.

##### Vertical swing.

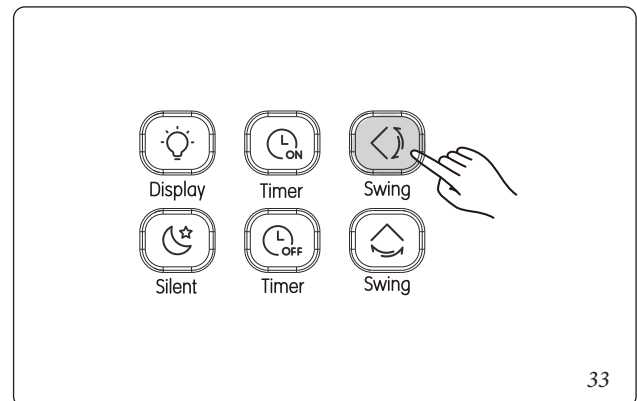
1) When the unit is on press  to start the vertical swing function:  will light up and the signal is sent to the indoor unit.



2) When the vertical swing is on, press  to turn off this function.

##### Note:

- When the unit is turned off, the button is invalid.
- Each time the vertical swing signal is sent, the icon keeps lighting up for 15 seconds and then disappears. The indoor unit remains vertical swing operation.



### IDU Display.

The Display function is used to control the on/off state of the display in the indoor unit.



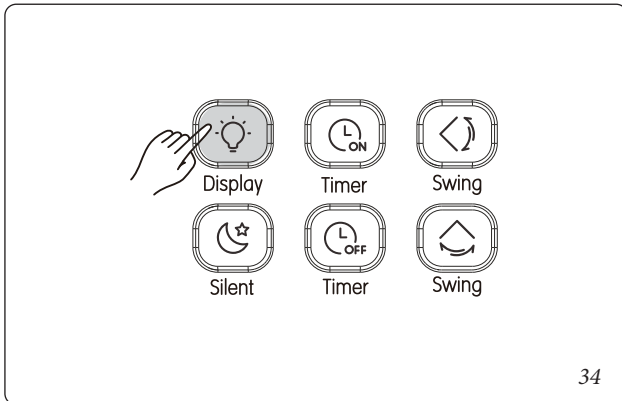



- 1) Press  regardless of the remote control status (on or off).



- 2) When the display of the indoor unit lights up, press  to turn off the light.

### ECO operation.

The remote controller sends the ECO signal when the unit is operating in Cool or Heat mode.

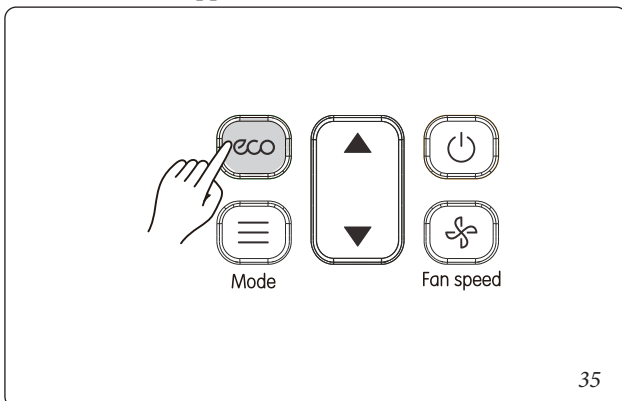

- 1) Press  to send the ECO signal to the indoor unit. The  icon is displayed;
- 1) Then press , ,  or  to exit the ECO function. The  icon disappears.







#### Note:

- In cooling mode, when ECO is set up, the Fan Speed is forced to Auto and the temperature is 26°C; in heating mode, when ECO is set up, the Fan Speed is forced to Auto and the temperature does not change.
- Once it has been running for 8 hours,  will no longer light up, and the unit will exit the ECO mode.
- The Silent (not on this model) and ECO functions cannot be implemented at the same time.

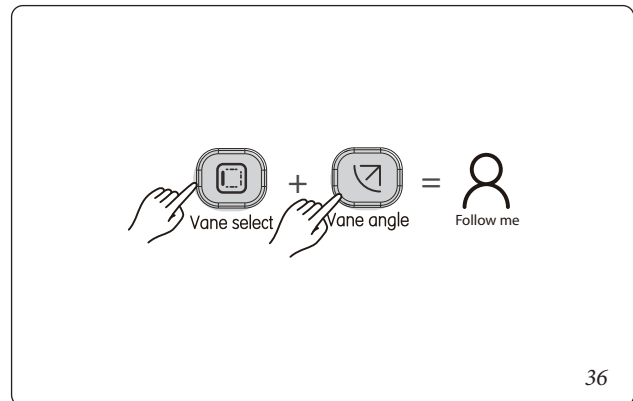
### Follow Me.

- 1) When the unit is in the Cool or Heat mode, press  and  at the same time to start the Follow Me function. The screen will display the  icon.



- 2) The displayed temperature is the room temperature detected by the remote controller.
- 3) When the Follow Me function is on, press  and  at the same time to turn off this function, and the  icon will disappear from the display.

### Timer On/Off.

“Timer” is used to set the timed on/off state of indoor unit.

- Timer switch-on:

- 1) With the appliance in stand-by press  and the remote controller will display “Timer On”, and “0.0H” will appear in the timer area.

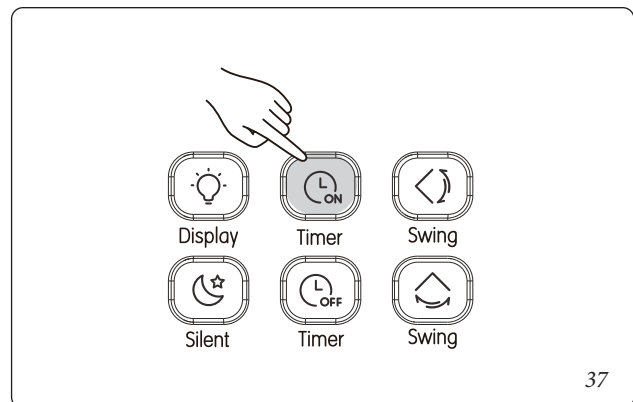



- 2) Press  to set the number of hours after which the appliance will turn on automatically with the last adjustments of the remote control.
- 3) Once the adjustment is done, the timer information is sent to the indoor unit.

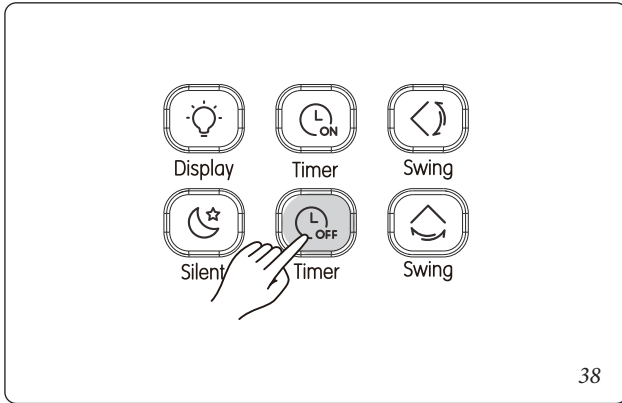

- Timer switch-off:

1) With the appliance in the intended mode - by press  : and the remote controller will display “Timer Off”, and “0.0H” will appear in the timer area. With the appliance running, use the ▼ and ▲ keys to set the number of hours of operation of the appliance, after which it will turn off automatically.







2) Press  to set the number of hours after which the appliance will turn off automatically.  
 3) Once the adjustment is done, the timer information is sent to the indoor unit.

**Note:**

- Timer Off can be set only when the unit is powered on and Timer On can be set only when the unit is powered off.
- When Timer On is being set, you can set the power-on mode, fan speed, and temperature.
- If the timing period is more than 10 hours, the timing period increases by 1 hour.
- To change the time: Press the corresponding button, change the time, and then confirm the changes.
- Adjust the Timer On or Timer Off to 0.0h to cancel the Timer On or Timer Off settings.

**Button lock.**

Once the buttons on the remote controllers are locked, all the other button operations except for Unlock and IDU Address Setting are invalid.

1) Press  and  at the same time to lock the button, and the screen will display the lock icon.  
 2) Press  and  at the same time, and the lock icon  will disappear. Button is unlocked.

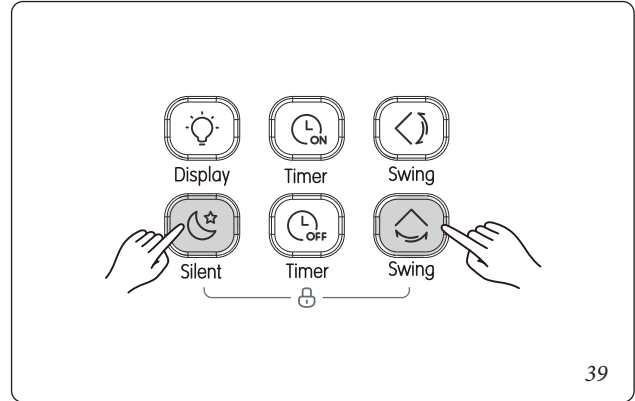



# 5 RECOMMENDATIONS - MAINTENANCE AND REPAIRS

## 5.1 ADVICE FOR THE USER.

- Make sure there are no obstructions along the drain or on the air intake.
- Make sure the earthing wire is connected properly.
- Replace the filters if necessary.
- Make sure there are no obstacles between the remote control and the indoor unit's receiver, otherwise the signal will not reach the fan coil.
- Keep the remote control away from liquids.
- Protect the remote control from high temperatures and do not expose it to direct sunlight.
- Do not let the receiver be exposed to direct sunlight, otherwise it could malfunction.
- Keep the remote control away from equipment that could give rise to electromagnetic interference, such as: televisions, audio-video systems, electric ovens, etc.

### Important note - End of the device's service life:

- At the end of its service life, the device must be taken to a sorting centre for electrical and electronic equipment. Do not dispose of the device with household waste, but dispose of it in the collection centres provided, where it can be recycled. Check your local collection service to find out about existing waste collection centres. Disposal of electrical appliances at non-authorised landfills could result in hazardous substances being dumped into groundwater, and consequent insertion into the food chain, with harm being caused to the health and well-being of users.



## 5.2 HOUSEHOLD MAINTENANCE.

**Note:** before cleaning the fan coil, make sure it is unplugged.

**Note:** make sure the wiring is not broken or disconnected.

**Note:** clean the indoor unit and the remote control with a dry cloth.

**Note:** a wet cloth may be used to clean the indoor unit if it is very dirty.

**Note:** never use a wet cloth on the remote control.

**Note:** do not dry the unit with chemically treated cloths or leave them on it for a prolonged period to avoid damaging or discolouring the surface.

**Note:** do not use petrol, thinners, powder detergents or other similar cleaning solvents as they may break or deform the plastic surface.

### • Maintenance after a long downtime (e.g.: at the beginning of the season).

Check and remove any object that can block the inlet and outlet vents of the indoor and outdoor units.

Clean the filters and casings of the indoor units.

See the "Cleaning the air filter" section for more information and make sure the air filters are installed in the same position.

### • Maintenance before a long downtime (e.g.: at the beginning of the winter season).

To avoid the risk of breakage due to freezing, it is advisable to drain the water from the system at the beginning of the winter season.

### • Maintenance before a long downtime (e.g.: at the end of the season).

Leave the indoor units working with only the fans running for approximately half a day to dry all of the internal parts.

Clean the filters and casings of the indoor units. See the "Cleaning the air filter" section for more information and make sure the air filters are installed in the same position.

Take the batteries out of the remote control.



• **Cleaning the air filter and the clean air grid.**

The air filter can prevent the infiltration of dust or other particles. If it is clogged, the operating efficiency of the fan coil can reduce significantly.

It is therefore necessary to clean the filter at least once a fortnight during its period of use.

Clean the air filter frequently if the fan coil is installed in a dusty environment.

If the accumulated dust is too much to be removed, replace the filter (a replacement filter is an optional accessory).

- Open the front panel and remove the air filter and the optional additional filter (Fig. 40).
- Clean air filters.

The filter can be cleaned with a vacuum cleaner or clean water. If the amount of accumulated dust is excessive, use a soft bristled brush and a mild detergent, then leave it to dry in a cool place.

The air inlet side must face upwards when using a vacuum cleaner (Fig. 41).

The air inlet side must face downwards when using water (Fig. 42).

- Remounting the air filter and the clean air grid
- Close the front panel.

**Note:** do not dry the air filter in direct sunlight or near a fire.

**Note:** do not leave in operation without filter.

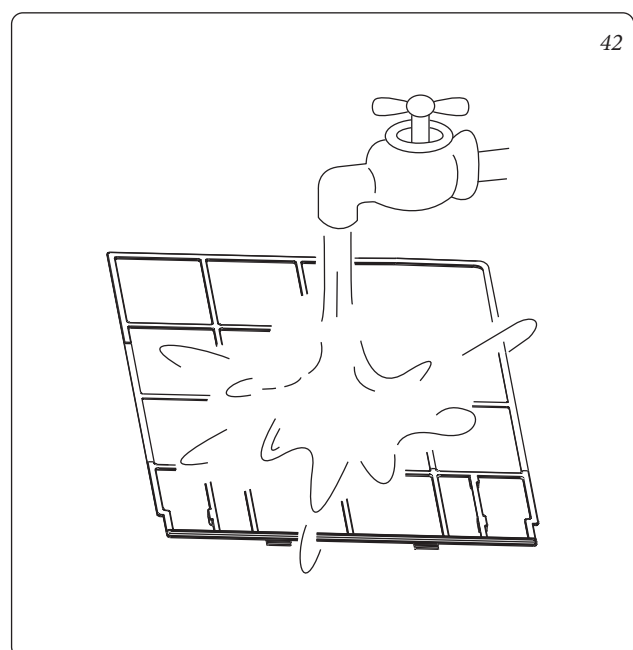
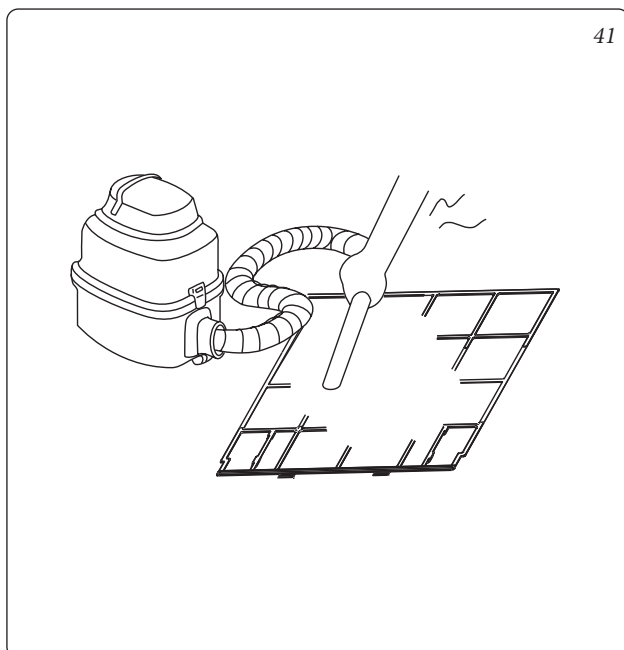
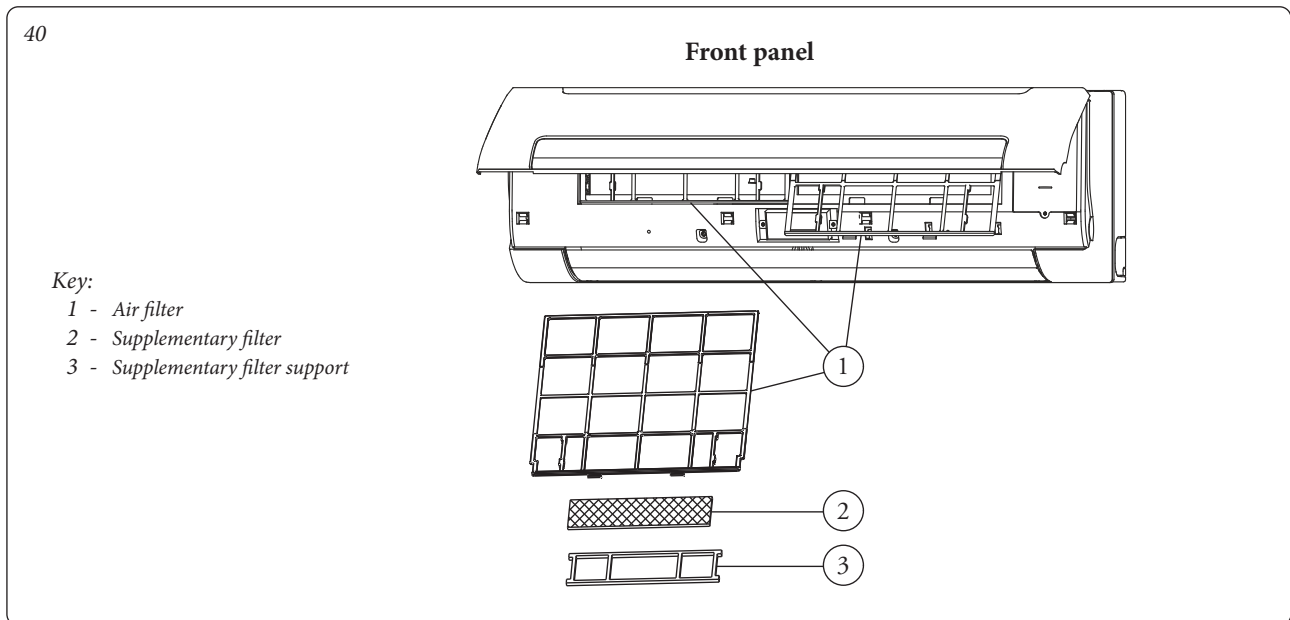

**5.3 THE FOLLOWING SYMPTOMS DO NOT  
CONSTITUTE A PROBLEM FOR THE FAN COIL.**

Symptoms	Status
The system does not work.	<ul style="list-style-type: none"> <li>The fan coil does not start immediately after the ON/OFF key is pressed on the remote control. If the operation LED flashes, the system is in normal condition.</li> </ul>
Changing to "FAN" mode during cooling mode.	<ul style="list-style-type: none"> <li>To prevent the internal evaporator from freezing, the system automatically changes to "FAN" mode and then returns to cooling mode after a few moments.</li> <li>If the room temperature drops to the set-point, the indoor unit changes to "FAN" mode. The same applies to the heating mode.</li> </ul>
White fog is coming out of the unit.	<ul style="list-style-type: none"> <li>When, during cooling, the humidity level is particularly high. If the inside of the indoor unit is extremely clogged, distribution of the temperature in the room becomes irregular. In this case, the inside of the indoor unit needs cleaning. Call your dealer for more information. This operation must be carried out by qualified staff.</li> </ul>
Fan coil cooling noise.	<ul style="list-style-type: none"> <li>When the system stops after a heating operation, a sharp sound can be heard. This noise is produced by the expansion and contraction of plastic parts caused by a variation in the temperature.</li> <li>A continuous and low "hiss" might be heard when the fan coil is running. This is caused by the water flow.</li> <li>A low hiss might be heard when the unit is started or as soon as it has stopped: this is caused by a variation in the water flow or it stopping.</li> </ul>
Dust is coming out of the unit.	<ul style="list-style-type: none"> <li>When the unit is used for the first time after a long time. This occurs because there is dust inside the unit.</li> </ul>
The unit can give off a bad smell.	<ul style="list-style-type: none"> <li>The unit absorbs the smells of the rooms, furniture, cigarettes, etc. and re-emits them.</li> </ul>
The fan does not turn.	<ul style="list-style-type: none"> <li>During operation. The fan speed is controlled so as to optimise system operation.</li> </ul>



## 5.4 TROUBLESHOOTING SUPPORT.

### Fan coil problems and their causes.

**Note:** if one of the following malfunctions occurs, stop the device, unplug it and contact the service centre.

- The operation LED flashes quickly (twice per second).
- This lamp is still flashing rapidly after turn off the power and turn on again.
- Remote controller receives malfunction or the button does not work well.
- A safety device such as a fuse, a breaker frequently actuates.
- Water leaks from indoor unit.
- Strange objects or substances inside the unit.
- Other malfunctions.

Symptoms	Causes	Solution
The unit does not start.	Supply voltage problem. The main switch is off.	Wait for the supply voltage to be restored. Connect the supply voltage.
	The main switch fuse could be blown.	Replace the fuse.
	Flat batteries or other problems with the remote control.	Replace the batteries or check the remote control.
Air flowing normally but completely can't cooling	The temperature is not set correctly.	Set the temperature correctly.
Cooling insufficient	Indoor unit heat exchanger is dirty.	Clean the heat exchanger.
	The air filter is dirty.	Clean the air filter.
	Inlet of indoor units is blocked.	Remove the dirt and make the air even.
	Doors and windows are open.	Close doors and windows.
	Direct sunlight.	Hang curtains to protect from direct sunlight.
	Excessive heating.	Limit the source of heat.
Insufficient heating	Outside temperature too high.	Reduce the CA cooling capacity (normal).
	Doors and windows are not fully closed.	Close doors and windows.
Water leaks from the unit	The condensate water in the drain pipe is too cold and freezing.	Cover the drain pipe with insulation cotton.
	The drain pipe is clogged and broken.	Repair or replace the drain pipe.
	Properly connect the connecting pipe's inlet/outlet.	Connect the piping properly.
	The drain pipe outlet is higher and so causes water to leak from the condensate collection tank.	Position the condensate drain pipe lower than the bottom of the unit.
	The unit is too inclined.	Position the unit horizontally.
	The unit works in high speed.	Adjust the fan to medium or low speed.



### Remote control problems and their causes.

**Note:** check the points in the table below before requesting service or repairs.

Symptoms	Causes	Solution
The fan speed cannot be changed.	Check if the mode indicated on the display is "AUTO".	When automatic mode is selected, the fan coil automatically changes the fan speed.
	Protection from hot air in cooling mode. Protection from cold air in heating mode.	Reduce the water inlet temperature in cooling mode, increase it in heating mode.
	Check if the mode indicated on the display is DRY.	When DRY mode is selected, the fan coil automatically selects the fan speed. The fan speed can be selected during COOLING, FAN ONLY and heating modes.
The remote control signal is not transmitted, not even when ON/OFF is pressed.	Check whether the batteries in the remote control are flat.	The supply voltage is not on.
The TEMP. indicator does not switch on.	Check if the mode indicated on the display is "FAN ONLY".	The temperature cannot be set in "FAN" mode.
The indication on the display disappears after a few seconds.	Check if operation of the timer stops when TIMER OFF appears on the display.	The fan coil will stop working after the predefined interval.
The TIMER ON indicator switches off after the predefined interval.	Check if operation of the timer starts when TIMER ON appears on the display.	When the predefined interval is reached, the fan coil starts automatically and the corresponding LED switches off.
The indoor unit does not emit any sound, not even when ON/OFF is pressed.	Check if the remote control's signal transmitter is properly directed towards the indoor unit's infrared signal receiver when ON/OFF is pressed.	Direct the remote control's signal transmitter properly towards the indoor unit's infrared signal receiver and press ON/OFF twice.

### Error codes.

**Note:** if any of the following malfunctions occur, do not try to repair the unit yourself but contact your dealer.

Make sure you provide precise information on the type of fault and the device model.

Codes	Description of the errors
E2	T1 air sensor malfunction.
E3	T2 evaporator sensor malfunction.
E7	EEPROM communication error.
E8	DC motor malfunction.
EE	Tripped high level water condensate switch
P0	Water system low temperature protection
P1	Water system high temperature protection



## 6 INFORMATION REQUIREMENTS FOR FAN COILS.

Model HYDRO 3 V2			
Element	Symbol	Value	Unit
Cooling capacity (sensitive)	$P_{rated,c}$	2.15	kW
Cooling capacity (latent)	$P_{rated,c}$	0.55	kW
Heating capacity	$P_{rated,h}$	2.94	kW
Total absorbed electric power	$P_{elec}$	0.013	kW
Sound power level for each selectable speed	$L_{WA}$	44/42/39	dB
Contact information: Immergas S.p.A. via Cisa Ligure, 95 Brescello (RE) - Italy			
Model HYDRO 4 V2			
Element	Symbol	Value	Unit
Cooling capacity (sensitive)	$P_{rated,c}$	3.18	kW
Cooling capacity (latent)	$P_{rated,c}$	0.63	kW
Heating capacity	$P_{rated,h}$	4.3	kW
Total absorbed electric power	$P_{elec}$	0.033	kW
Sound power level for each selectable speed	$L_{WA}$	57/51/47	dB
Contact information: Immergas S.p.A. via Cisa Ligure, 95 Brescello (RE) - Italy			

Cooling Conditions: Inlet water temperature 7°C, Outlet water temperature 12°C, Air temperature 27°C (dry bulb)/19°C (wet bulb).

Heating Conditions: Inlet water temperature 45°C, Outlet water temperature 40°C, Air temperature 20°C (dry bulb) /20°C (wet bulb) with the same water flow rate as in the cooling phase.



# 7 TECHNICAL DATA.

			HYDRO 3 V2	HYDRO 4 V2
Power supply		V / Ph / Hz	220 - 240 / 1 / 50	220 - 240 / 1 / 50
Air flow (H / M / L)		m <sup>3</sup> /h	492 / 454 / 400	825 / 689 / 590
		CFM	289 / 267 / 235	485 / 405 / 347
Cooling*	Cooling capacity (H / M / L)	kW	2.70 / 2.59 / 2.39	3.81 / 3.30 / 2.88
	Water flow rate (H / M / L)	m <sup>3</sup> /h	0.48 / 0.46 / 0.42	0.67 / 0.57 / 0.51
	Water pressure drop (H / M / L)	kPa	31.61 / 28.63 / 25.36	56.75 / 41.23 / 33.02
	Power input (H / M / L)	W	13 / 11 / 10	33 / 22 / 15
Heating**	Heating capacity (H / M / L)	kW	2.94 / 2.80 / 2.58	4.30 / 3.65 / 3.09
	Water flow rate (H / M / L)	m <sup>3</sup> /h	0.51 / 0.49 / 0.46	0.73 / 0.64 / 0.56
	Water pressure drop (H / M / L)	kPa	32.66 / 34.89 / 30.24	51.86 / 47.53 / 35.69
	Power input (H / M / L)	W	11 / 11 / 9	31 / 20 / 14
Heating***	Heating capacity (H / M / L)	kW	3.29 / 3.03 / 2.63	5.08 / 4.33 / 3.77
	Water flow rate (H / M / L)	m <sup>3</sup> /h	0.48 / 0.46 / 0.42	0.67 / 0.57 / 0.51
	Water pressure drop (H / M / L)	kPa	37.49 / 30.25 / 26.53	61.94 / 37.88 / 30.34
	Power input (H / M / L)	W	12 / 10 / 8	31 / 20 / 14
Sound pressure level (H / M / L)		dB (A)	32 / 30 / 27	45 / 39 / 35
Rated current		A	0.16	0.28
Fan motor	Type		Low noise 3-speed fan	
	Quantity		1	
Fan	Type		Tangential fan	
	Quantity		1	
Coil (finned)	Row		2	
	Max working pressure	MPa	1.6	
	Coil length x height	mm	635 x 26.74	
	Fin spacing	mm	1.5	
	Fin type		Hydrophilic aluminium	
	Number of circuits		5	
	Diameter	mm	7	
Body	Dimensions	mm	915 x 290 x 230	
	Packing Dimensions	mm	1020 x 390 x 315	
	Net weight	kg	12.7	
	Gross weight	kg	15.6	
Pipe connection	Water inlet / outlet pipes connections	Inch	G 3/4"	
	Drain pipe connection	mm	20	

- H: High fan speed; M: Medium fan speed; L: Low fan speed.

\* Conditions in Cooling: Inlet water temperature 7 °C, Outlet water temperature 12 °C, Air temperature 27 °C (dry bulb) / 19 °C (wet bulb).

\*\* Conditions in Heating: Inlet water temperature 45 °C, Outlet water temperature 40 °C, Air temperature 20 °C (dry bulb) with the same water flow rate as the cooling phase.

\*\*\* Conditions in Heating: Inlet and Outlet water temperature 50 °C, Air temperature 20 °C (dry bulb) with the same water flow rate as the cooling phase.





**Immergas S.p.A.**

42041 Brescello (RE) - Italy

Tel. 0522.689011

**immergas.com**



 This instruction booklet  
is made of ecological paper

